



Grid-connected PV Inverter

SUN-35K-G02-LV

SUN-40K-G-LV

SUN-45K-G-LV

SUN-50K-G-LV

User Manual

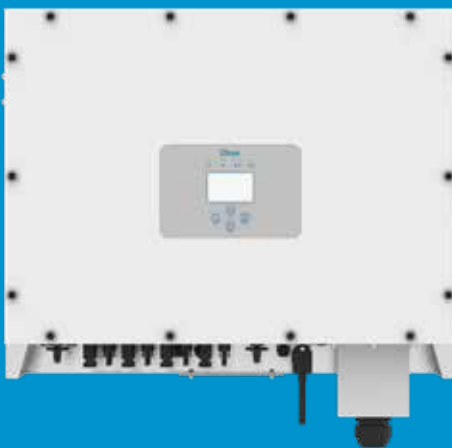

Contents

1. Introduction	- 1 -
1.1 Appearance introduction	- 1 -
1.2 Parts list	- 2 -
2. Safety warnings and instructions	- 3 -
2.1 Safety signs	- 3 -
2.2 Safety instructions	- 3 -
2.3 Notes for using	- 4 -
3. Operation interface	- 5 -
3.1 Interface view	- 5 -
3.2 Status indicator	- 5 -
3.3 Buttons	- 6 -
3.4 LCD display	- 6 -
4. Product Installation	- 7 -
4.1 Select installation location	- 7 -
4.2 Inverter of inverter	- 9 -
4.3 Inverter Installation	- 10 -
5. Electrical connection	- 11 -
5.1 DC input terminal connection	- 11 -
5.2 AC terminal connection	- 13 -
5.3 Connection of the ground line	- 16 -
5.4 Inverter monitoring connection	- 16 -
6. Start up and shut off	- 18 -
6.1 Start up the inverter	- 18 -
6.2 Shut off the inverter	- 18 -
7. Zero-export function via energy meter	- 19 -
7.1 Multiple strings and parallel connection meters	- 24 -
7.2 How to browse the load power of your PV grid-tie plant on monitoring platform?	- 29 -
8. General Operation	- 31 -
8.1 The initial interface	- 34 -
8.2 Statistics information	- 36 -
8.3 Fault Record	- 38 -
8.4 ON/OFF setting	- 39 -
8.5 Parameter setting	- 40 -
9. Repair and Maintenance	- 58 -
10. Error information and processing	- 58 -
10.1 Error code	- 58 -
11. Specifications	- 63 -

About This Manual

The manual mainly describes the product information, guidelines for installation, operation and maintenance. The manual cannot include complete information about the photovoltaic (PV) system.

How to Use This Manual

Read the manual and other related documents before performing any operation on the inverter. Documents must be stored carefully and be available at all times. **Contents may be periodically updated or revised due to product development. The information in this manual is subject to change without notice.** The latest manual can be acquired via service@deye.com.cn

1. Introduction

1.1 Appearance Introduction

On-grid inverter can convert solar panel DC power into AC power which can directly input to the grid. Its appearance is shown below. These models contain SUN-35K-G02-LV, SUN-40K-G-LV, SUN-45K-G-LV, SUN-50K-G-LV. The following is collectively referred to as “inverter”.

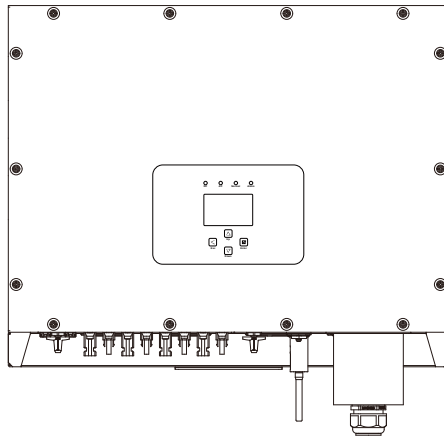

Pic 1.1 Front view

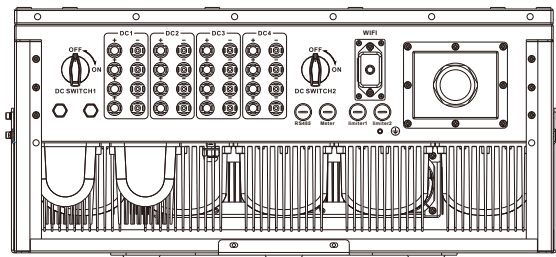

Pic 1.2 Bottom view

1.2 Parts list

Please check the following table, to see whether all the parts are included in the package :

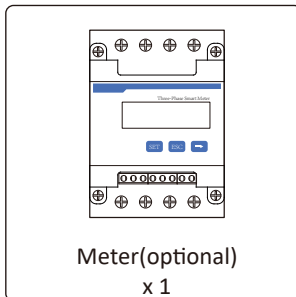
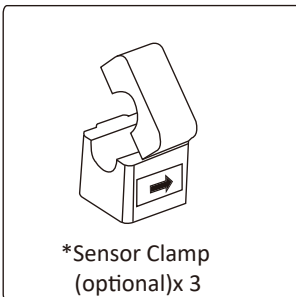
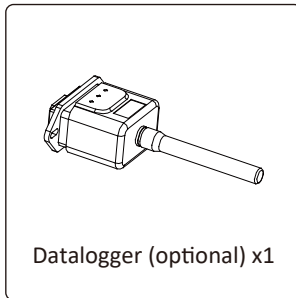
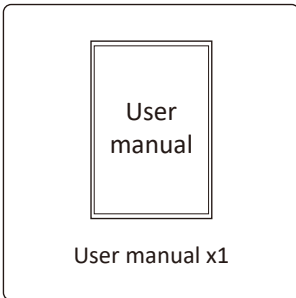
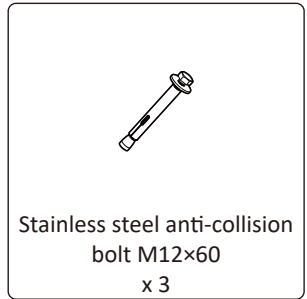
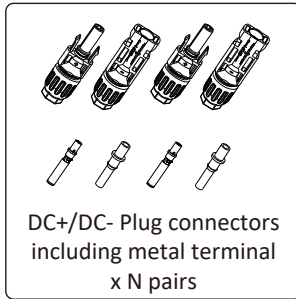
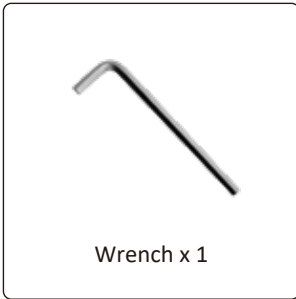
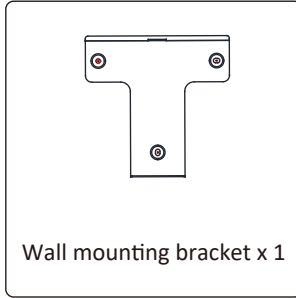
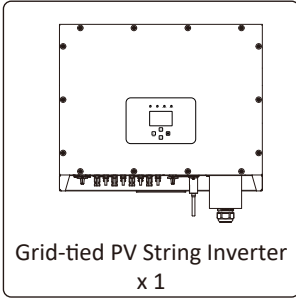

2. Safety warnings and instructions

Improper use may result in potential electric shock hazards or burns. This manual contains important instructions that should be followed during installation and maintenance. Please read these instructions carefully before use and keep them for future reference.

2.1 Safety signs

Safety symbols used in this manual, which highlight potential safety risks and important safety information, are listed as follows:



Warning:

Warning symbol indicates important safety instructions, which if not correctly followed, could result in serious injury or death.



Shock Hazard:

Caution, risk of electric shock symbol indicates important safety instructions, which if not correctly followed, could result in electric shock.



Safety Hint:

Note symbol indicates important safety instructions, which if not correctly followed, could result in some damage or the destruction of the inverter.



High Temperature Hazard:

Caution, hot surface symbol indicates safety instructions, which if not correctly followed, could result in burns.

2.2 Safety instructions



Warning:

Electrical installation of the inverter must conform to the safety operation rules of the country or local area.



Warning:

Inverter adopts non-isolated topology structure, hence must insure DC input and AC output are electrical isolated before operating the inverter.



Shock Hazard:

Prohibit disassembling inverter case, there existing shock hazard, which may cause serious injury or death, please ask qualified person to repair.



Shock Hazard:

When PV module is exposed to sunlight, the output will generate DC voltage. Prohibit touching to avoid shock hazard.



Shock Hazard:

While disconnect the input and output of the inverter for maintenance, please waits for at least 5 mins until the inverter discharge the remnant electricity.



High Temperature Hazard:

Local temperature of inverter may exceed 80 °C while under operating. Please do not touch the inverter case.

2.3 Notes for using

The three phase string power inverter is designed and tested under related safety regulations. It can ensure the personal safety of the user. But as a electric device, it may cause shock or injury by incorrect operation. Please operate the unit under below requirements:

1. Inverter should be installed and maintained by qualified person under local standard regulations.
2. Must disconnect the AC side first, then disconnect DC side while doing installation and maintenance, after that, please wait at least 5 mins to avoid getting shocked.
3. Local temperature of the inverter may exceed 80 °C while under operating. Do not touch to avoid getting injured.
4. All electrical installation must be in accordance with local electrical standards, and achieved permission of local power company.
5. Please take appropriate anti-static measure.
6. Please install where children can not touch.

3. Operation Interface

3.1 Interface View

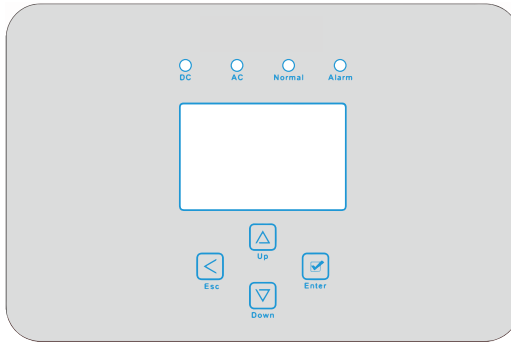

Pic 3.1 Front panel display

3.2 Status Indicator

The inverter panel has 4 indicators, the left one is dc output indicators, green indicates normal DC input. Beside is the AC indicator, green indicating normal ac connection. Beside the AC indicator is the operating indicator, green indicating normal output. The right indicator is alarm. red indicates alarming.

Indicator	status	Explanation
● DC	on	Inverter detects DC input
	off	Low DC input voltage
● AC	on	Grid Connected
	off	Grid Unavailable
● NORMAL	on	Under normal operating
	off	Stop operating
● ALARM	on	Detected faults or report faults
	off	Under normal operating

Table 3.1 Status indicator lights

3.3 Buttons

There are four buttons on the inverter panel: Above is Up and increase button (UP), Below is down and decrease button (DOWN), Left is ESC button (ESC), Right is Enter button (ENTER). Achieving below functions by the four buttons:

- Page turning (use UP and DOWN button)
- Modify adjustable parameters (use ESC and ENTER button)

3.4 LCD Display

Three phase string inverter use 256*128 dot formation display, Display below content:

- Inverter operation status and information;
- Operating information;
- Warning message and malfunction display.

4. Product installation

4.1 Select installation location

To select a location for the inverter, the following criteria should be considered:

WARNING: Risk of fire

- Do not install the inverter in areas containing highly flammable materials or gases.
- Do not install the inverter in potentially explosive atmospheres.
- Do not install in small closed spaces where air can not circulate freely. To avoid overheating, always make sure the flow of air around the inverter is not blocked.
- Exposure to direct sunlight will increase the operational temperature of the inverter and may cause output power limiting. It is recommended that inverter installed to avoid direct sunlight or raining.
- To avoid overheating ambient air temperature must be considered when choosing the inverter installation location. It is recommended that using a sun shade minimizing direct sunlight when the ambient air temperature around the unit exceeds 100°F/40°C.

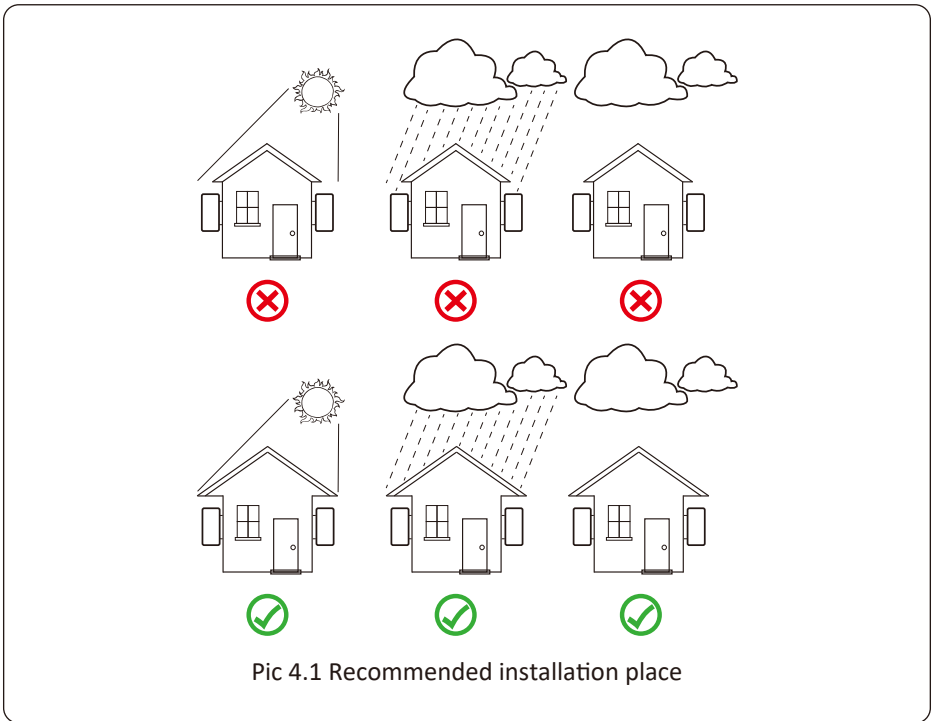

- Install on a wall or strong structure capable of bearing the weight.
- Install vertically with a maximum incline of $\pm 15^\circ$. If the mounted inverter is tilted to an angle greater than the maximum noted, heat dissipation can be inhibited, and may result in less than expected output power.
- If install more than one inverter, must leave at least 500mm gap between each inverter. And each inverter must be at least 500mm above and below. And must install the inverter at the place where children cannot touch. Please see picture 4.3.
- Consider whether the installation environment is helpful to see the inverter LCD display and indicator status clearly.
- Must offer a ventilate environment if inverter installed in the airtight house.



Safety Hint:

Do not place or store any items next to the inverter.

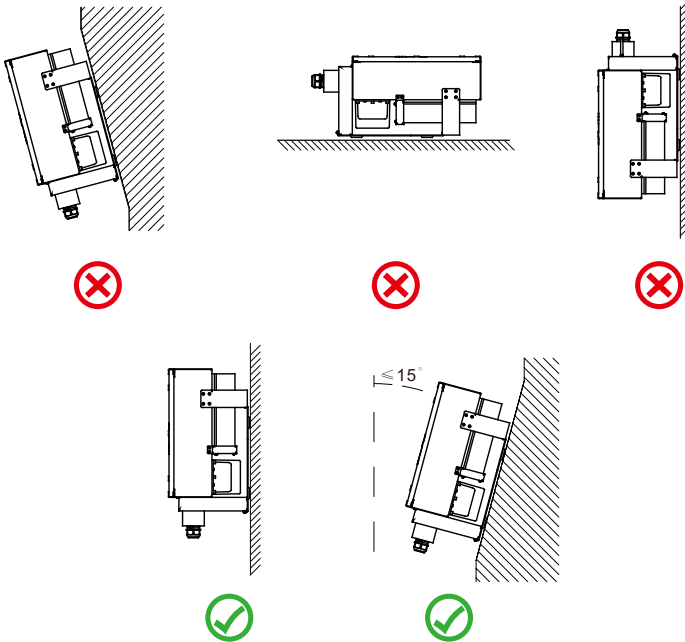

Pic 4.2 Installation Angle

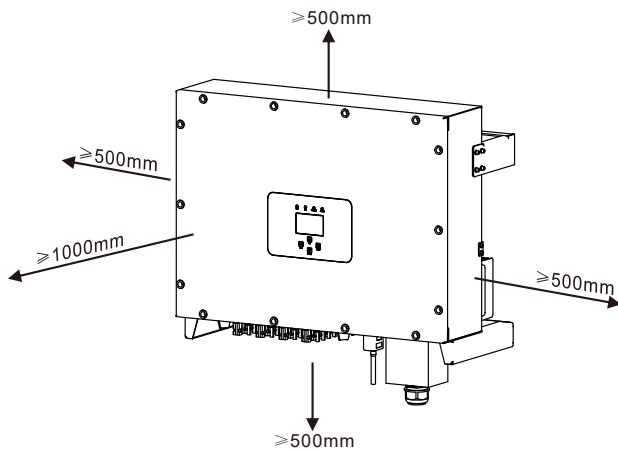

Pic 4.3 Installation Gap

4.2 Inverter of inverter

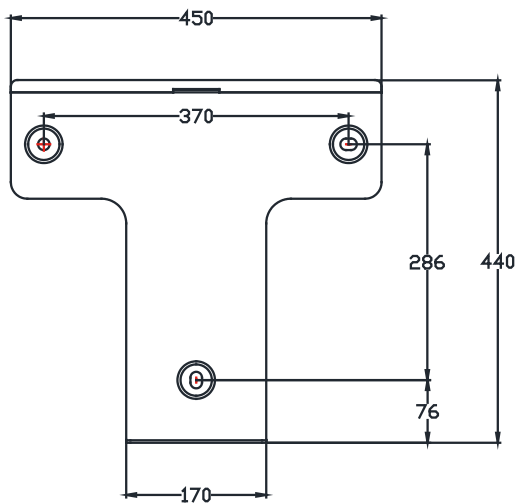

Pic 4.4 Mounting bracket dimensions

4.3 Inverter Installation

The inverter should be mounted in a vertical position. The steps of mounting are as follows

1. For brick walls, the position of the holes should be suitable for the expansion bolts.
2. Make sure the bracket is horizontal and the mounting holes are in the correct points. Drilling the holes on the wall according the marks.
3. Using the expansion bolts to fix the bracket to the wall.

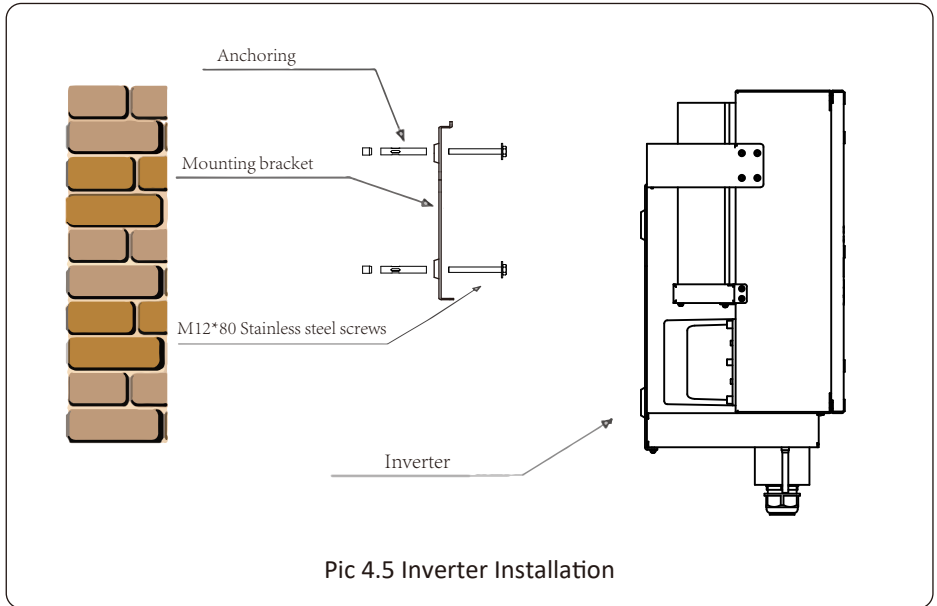

5 Electrical Connection

5.1 DC input terminal connection

1. Switch the Grid Supply Main Switch(AC)OFF.
2. Switch the DC Isolator OFF.
3. Assemble PV input connector to the inverter.



Warning:

When using PV modules, please ensure the PV+ & PV- of solar panel is not connected to the system ground bar.



Safety Hint:

Before connection, please make sure the polarity of the output voltage of PV array matches the “DC+” and “DC-” symbols.



Warning:

Before connecting inverter, please make sure the PV array open circuit voltage is within the 800V of the inverter.



Pic 5.1 DC+ male connector

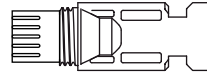

Pic 5.2 DC- female connector



Safety Hint:

Please use approved DC cable for PV system.

Cable type	Cross section (mm ²)	
	Range	Recommended value
Industry generic PV cable (model: PV1-F)	4.0~6.0 (12~10AWG)	4.0(12AWG)

Table 5.1 DC Cable Specifications

The steps to assemble the DC connectors are listed as follows:

a) Strip off the DC wire about 7mm, disassemble the connector cap nut (see picture 5.3).

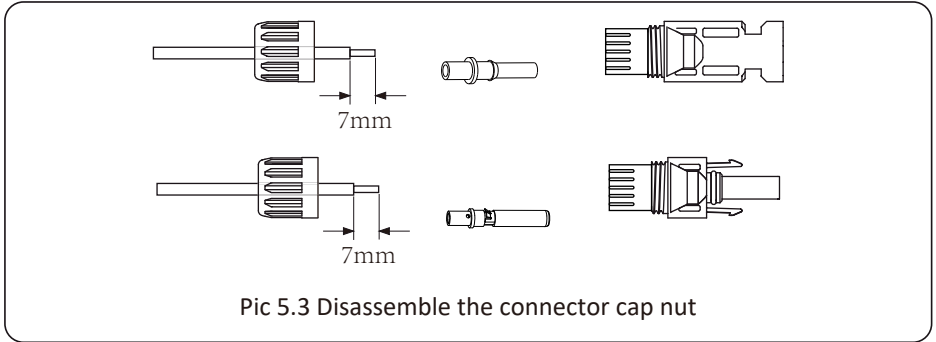

b) Crimping metal terminals with crimping pliers as shown in picture 5.4.

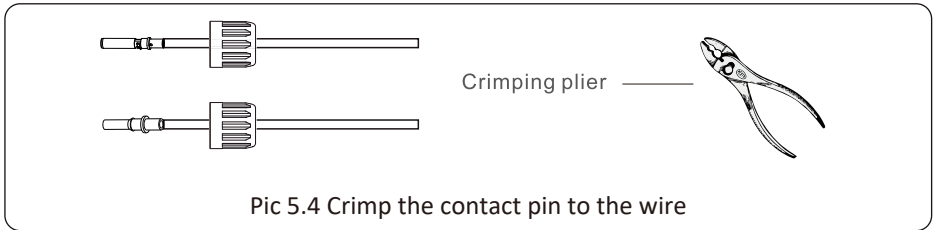

c) Insert the contact pin to the top part of the connector and screw up the cap nut to the top part of the connector. (as shown in picture 5.5).

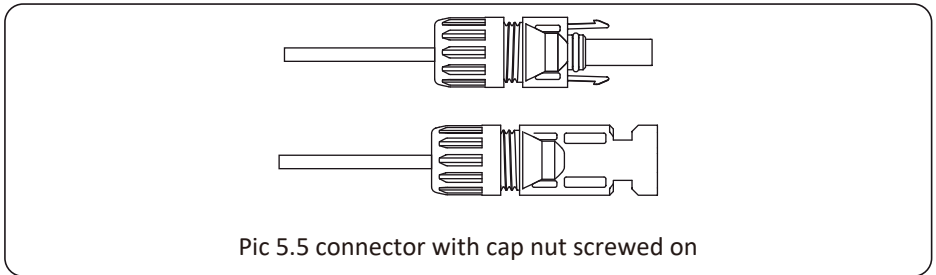

d) Finally insert the DC connector into the positive and negative input of the inverter, shown as picture 5.6

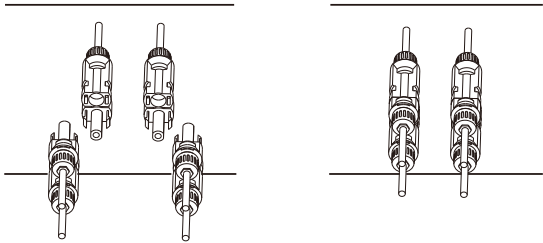

Pic 5.6 DC input connection



Warning:

Sunlight shines on the panel will generate voltage, high voltage in series may cause danger to life. Therefore, before connecting the DC input line, the solar panel needs to be blocked by the opaque material and the DC switch should be 'OFF', otherwise, the high voltage of the inverter may lead to life-threatening conditions.



Warning:

Please use its own DC power connector from the inverter accessories. Do not interconnect the connectors of different manufacturers. Max. DC input current should be 20A. if exceeds, it may damage the inverter and it is not covered by Deye warranty.

5.2 AC terminal connection

Cable specifications		Copper core cable
Conductor cross-sectional area (mm ²)	Recommended range	25-50

Table 5.2 Recommended cable specifications



Warning:

The AC cable line L1 is connected to socket 1; L2 is connected to socket 2; L3 is connected to socket 3, the PE line is connected to the earth , the N wire is connected to the socket of N.

AC wire production method is the same as that of 5.2.1.

AC wire installation method:

1) Remove the 8 fixing screws on the AC junction box of the inverter as shown in Pic 5.7. After removing the junction box, you can see the terminals of the inverter. The default is 5 digits as shown in Pic 5.8.

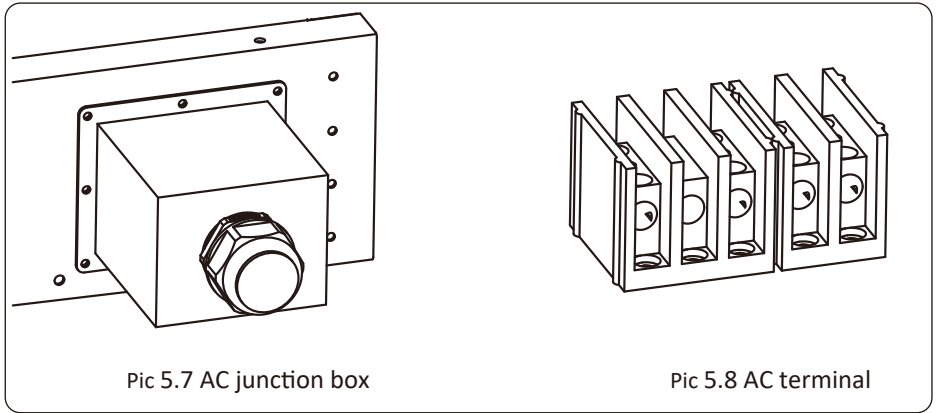

2) Connect the cable through the junction box, waterproof jacket, and insert into the terminal (The picture shows the connection mode of three phase lines connected to the junction box, ground wire screwed on the inverter shell) Pic5.9,and use hexagon screwdriver to presses the wiring harness to the connect terminal as shown in Pic5.10.

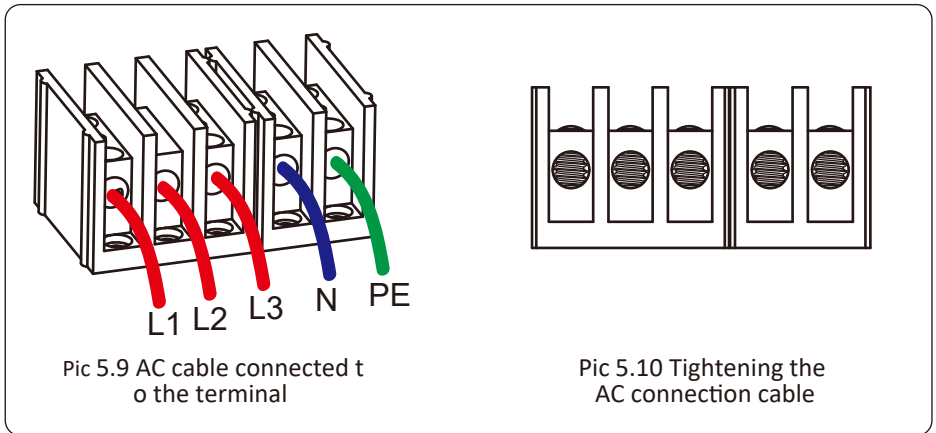

3) Screw the AC connection cover back to the shell and tighten all the screws to tighten the waterproof protection connector, as shown in Pic 5.11

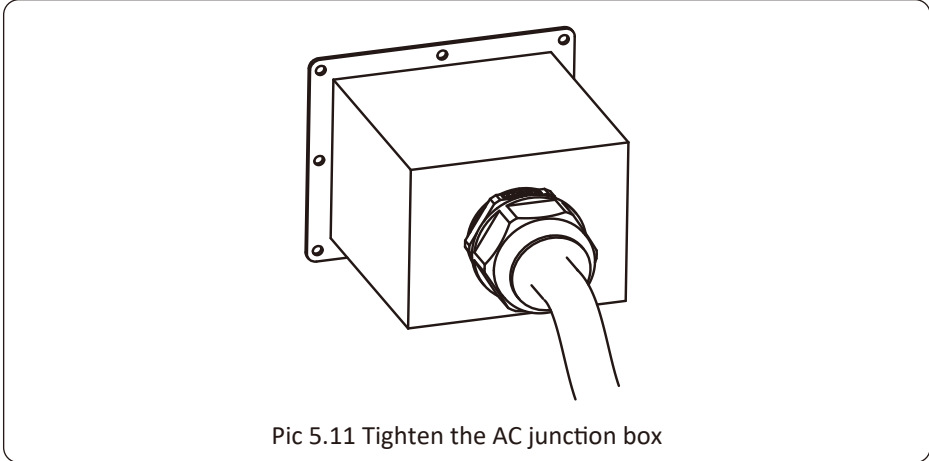

Pic 5.11 Tighten the AC junction box

5.2.3 Recommended current protector specifications

Inverter	Rated voltage	Rated output power (KW)	Current protection device (A)
SUN-35K-G02-LV	127	35	100
SUN-40K-G-LV	127	40	115
SUN-45K-G-LV	127	45	130
SUN-50K-G-LV	127	50	140

Table 5.3 Recommended current protector specifications

5.3 Connection of the ground line

Good grounded is important for resist the surge voltage shock and improve EMI's performance. So before the connection of AC, DC, communication connections, inverter needs to ground first. For a single system, just ground the PE cable; For multiple machine systems, all PE cables of the inverter need to be connected to the same grounding copper platoon to ensure the equipotent connection. The installation of the shell ground wire is shown as.

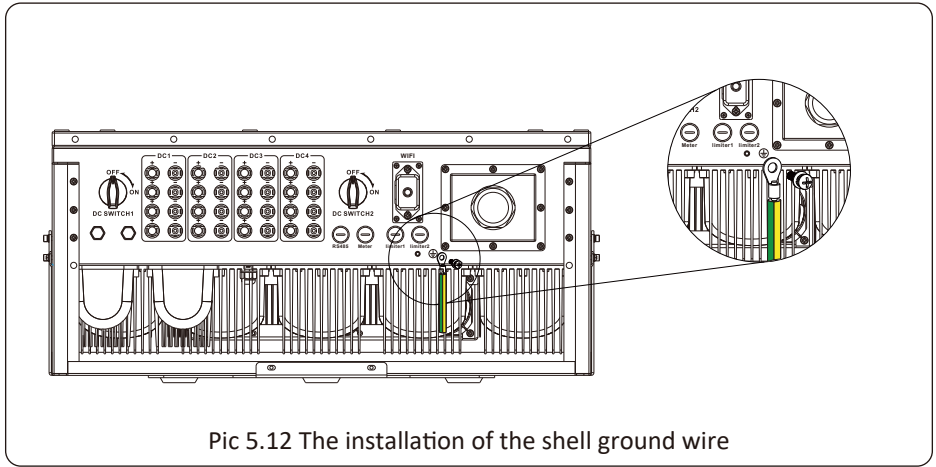

Warning:

Inverter has built-in leakage current detection circuit, If an external leakage current protection device is connected, its operating current must be greater than 300 mA or higher, otherwise inverter may not work properly.

5.4 Inverter monitoring connection

Inverter has the function of wireless remote monitoring inverter. The inverter has Wifi function and Wifi Plug in the accessories is used to realize the connection between the inverter and the network. The operation, installation, networking, APP download are detailed in the WIFI PLUG instructions. Figure 5.13 is the Internet monitoring solution.

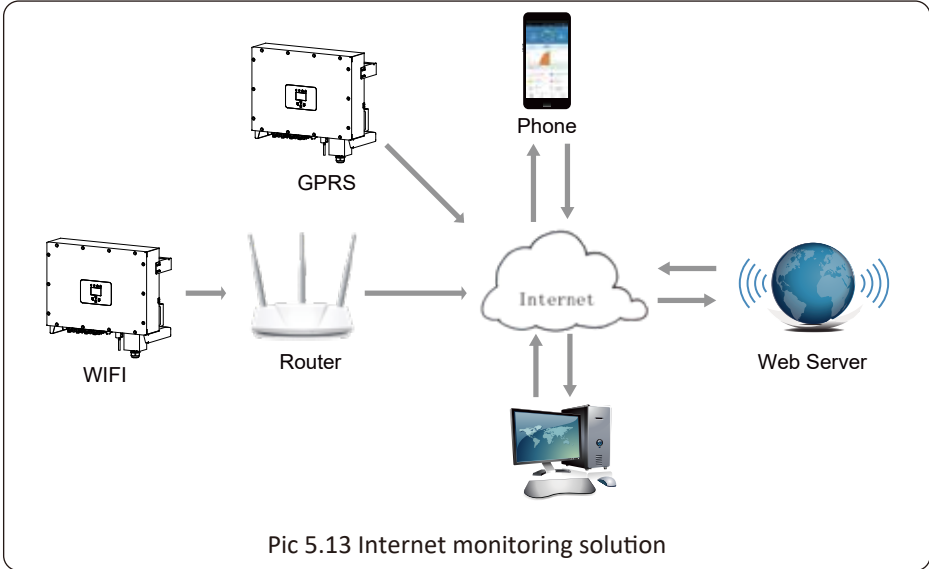

Pic 5.13 Internet monitoring solution

5.4.1 Installation of datalogger

When installing the WiFi stick, tear off the sealing strip on the inverter. Insert the datalogger into the interface and fix it with a screw. The configuration of the datalogger needs to be performed after various electrical connections have been completed and the inverter DC power on. When the inverter is on the DC power, it is determined whether the datalogger is normally electrified (The LED light shines out of the shell).

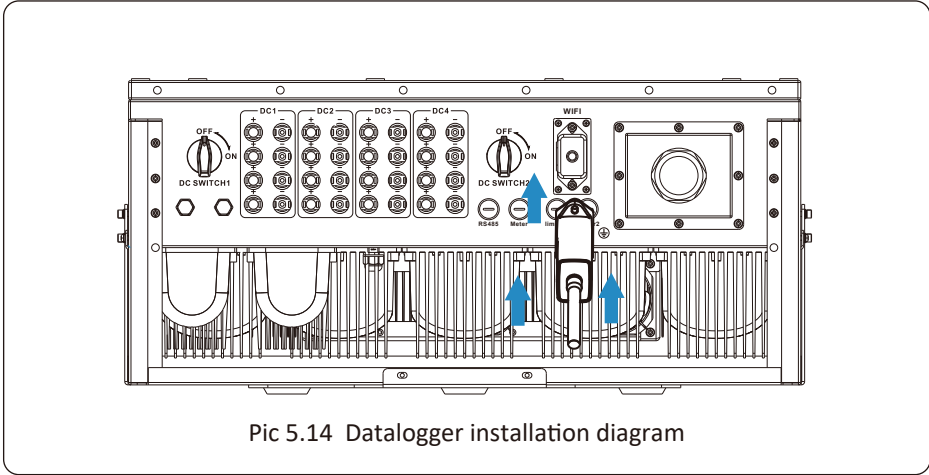

Pic 5.14 Datalogger installation diagram

5.4.2 Configuration of datalogger

For the configuration of datalogger, please refer to illustrations of the datalogger.

6. Start up and Shut off

Ensure that the inverter meets the following conditions before starting the inverter, otherwise it may cause fire or damage to the inverter without quality assurance, at the same time the situation on our company does not undertake any responsibility. At the same time, to optimize the system configuration, it is recommended that the two inputs be connected to the same number of PV modules.

- a). The maximum open circuit voltage of each set of PV modules shall not exceed 800Vdc under any conditions.
- b). Each input of the inverter better use the same type of PV module in series.
- c). Total output power of PV shall not exceed the maximum input power of inverter, each PV modules shall not exceed the rated power of each channel.

6.1 Start up the inverter

When starting up the three phase string inverter, should follow steps below :

1. Starting switch on the AC breaker.
2. Turn on the DC switch of the photovoltaic module, and if the panel provides sufficient starting voltage and power, the inverter will start.
3. The inverter will first check the internal parameters and the grid parameters, while the liquid crystal will show that the inverter is self-checking.
4. If the parameter is within acceptable range, the inverter will generate energy. NORMAL indicator light is on.

6.2 Inverter Shutdown

Must follow below steps while shutting down the inverter:

1. Switch off the AC breaker.
2. Wait for 30 seconds, turn off the DC switch (if any), or simply disconnect the DC input connector. The inverter will close the LCD and all LED within two minutes.

7. Zero-export function via energy meter

There're two kinds of energy meters for this series inverter. First type is Eastron SDM630-Modbus V2 which is able to measure the Max. 100A current directly. More details please refer to Pic 7.1 & 7.2. For the Eastron SDM630 MCT 40mA, it needs external CT to measure the current. The CT power range is from 5A-2000A. More details about the Eastron SDM630 MCT, please refer to Pic 7.3 & 7.4. Also, the CHNT meter DTSU666 is supported, it can measure the Max. 80A current directly. More details about the DTSU666, please refer to Pic 7.5 & 7.6.

When you are reading this, we believe that you have completed the connection according to the requirements of chapter 5, if you have been running your inverter at this time, and you want to use the zero-export function, please turn off AC and DC switch of the inverter, and wait for 5 minutes until the inverter completely discharged.

For system wiring diagram, the red line refers to L line (L1, L2, L3), the black line refers to the neutral line (N). Connecting energy meter RS485 cable to inverter's RS485 port. It's recommended to install an AC switch between the inverter and the utility grid, the specs of the AC switch are determined by the power of load.

If there is no integrated DC switch inside the inverter you purchased, we commend you to connect the DC switch. The voltage and current of the switch depend on the PV array you access.



Eastron SDM630-Modbus V2

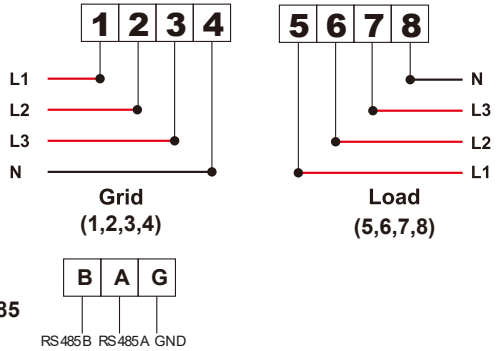

Pic 7.1 Eastron meter

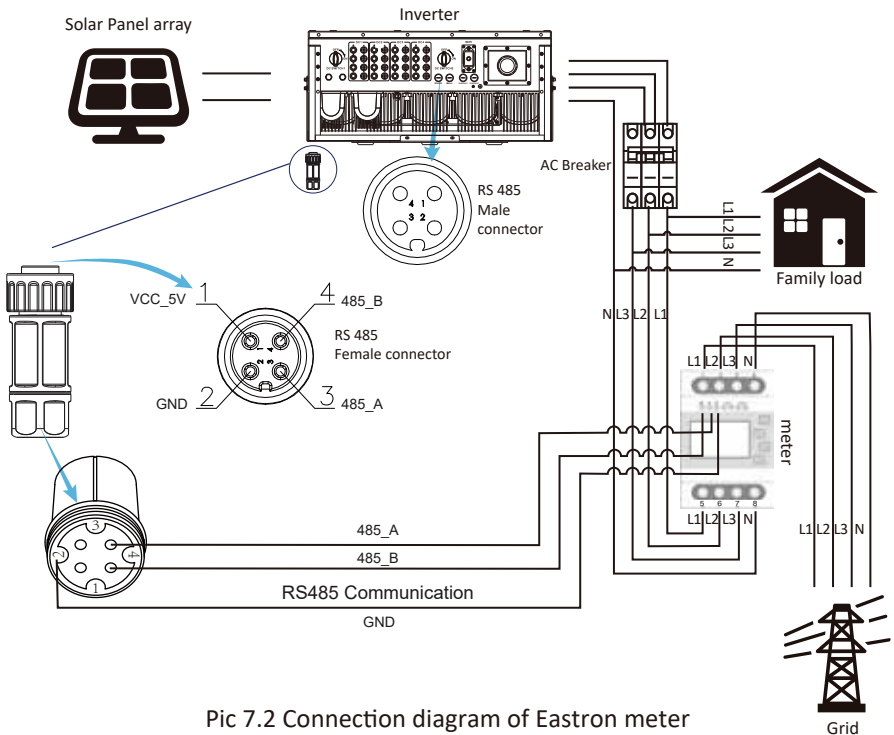

Pic 7.2 Connection diagram of Eastron meter



Warning:

In final installation, breaker certified according to IEC 60947-1 and IEC 60947-2 shall be installed with the equipment.

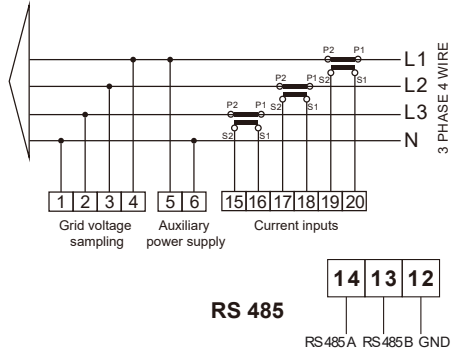
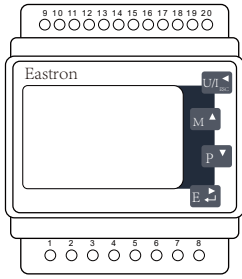

Eastron SDM630MCT

Pic 7.3 Eastron meter

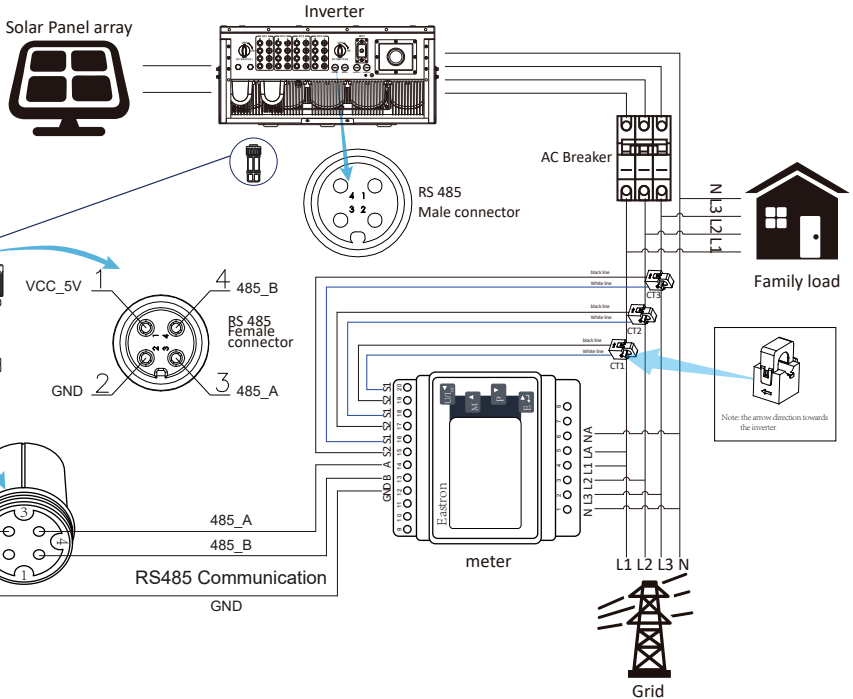

Pic 7.4 Connection diagram of Eastron meter

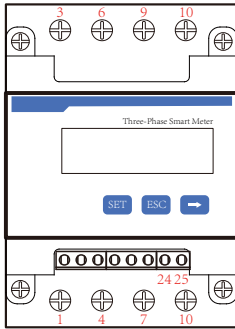

CHNT DTSU666

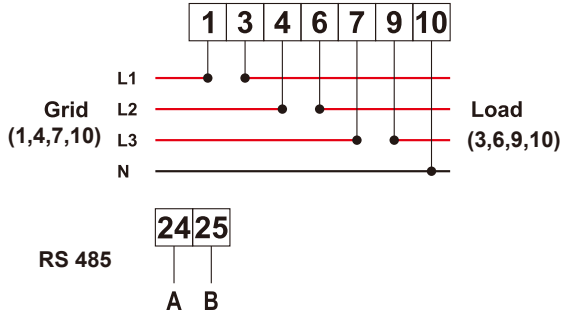

Pic 7.5 CHNT meter

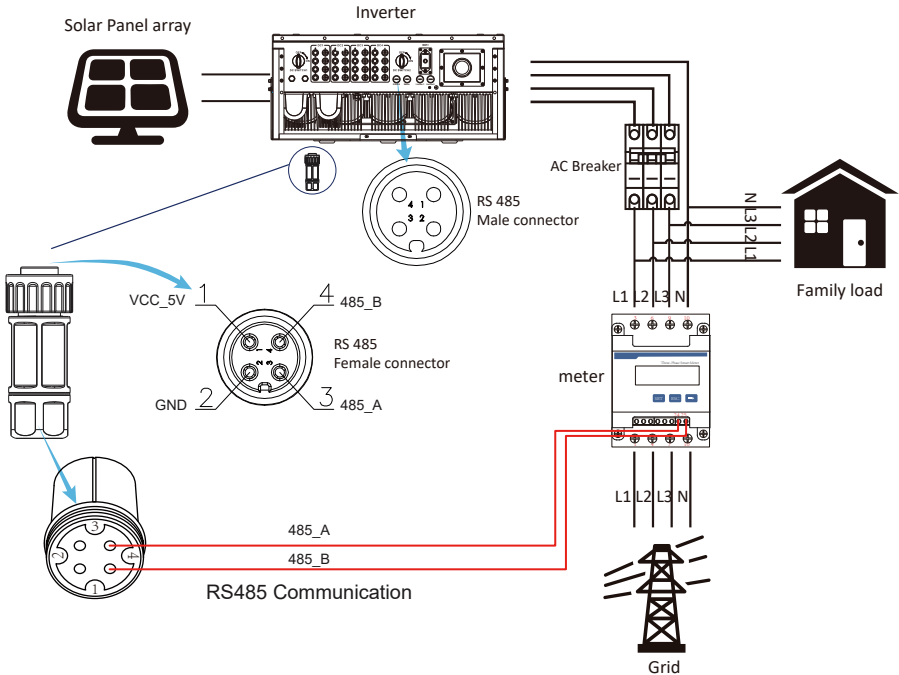

Pic 7.6 Connection diagram of CHNT meter



Safety Hint:

Ensuring grid input cables connect 1/4/7/10 port of energy meter, and inverter AC output cables connect 3/6/9/10 port of energy meter when connecting.

1. Press Enter button on the LCD panel in the main interface into the menu options, select [parameter setting] to enter setup submenu, and then select [run_param], at this time please input the default password 1234 through pressing the button [up down, enter], enter the operation parameter setting interface, shown as picture 7.7.

MENU» Setup» Run Param			
ActiveP	31%	SelfCheck	20S
QMode	QU	Island	OFF
ReactP	0.0%	Meter	ON
PF	1.000	Limiter	OFF
Fun_ISO	ON	Feed_In	0%
Fun_RCD	ON	MPPT Num	6
OK		Cancel	

Pic 7.7 Zero-export function via meter setting interface

2. Operate the button [up down], move setting cursor to energy meter and press the button [enter]. At this time you can turn on the energy meter by choosing [up down] button, please press [enter] button to confirm when setting done.
3. Move the cursor to [OK], press [enter] to save the settings and exit the running parameters page, otherwise the settings are invalid.
4. If set up successfully, you can return to the menu interface, and display the LCD to [home page] by press the [up down] button. If it displays [meter power XXW], the zero-export function setting is completed. Shown as picture 7.8.

PARAMETR	Meter
	SN:1
Meter Power:	428W
Load Power:	1.043kW
	Day Total
ImpEp : 9.51kWh	2.24MWh
ExpEp : 0.00kWh	574.75KWh
LoadEp : 13.71kWh	1.67MWh

Pic 7.8 Zero-export function via energy meter turn on

5. Meter power 428W shows positive means grid is supplying the load, and no power fed into grid. if meter power shows negative, it means PV energy is being sold to grid or energy meter wiring connection has problem.
6. After properly connection is done, wait for inverter starting. If the power of the PV array meets the current power consumption, the inverter will keep a certain output to counteract the power of the grid without backflow .

7.1 Multiple strings and parallel connection meters

This application is that when the string inverters work in parallel, there is only one power grid and one load, and only one meter can be connected to prevent reverse current, so only this many-to-one anti-reverse current connection can be connected.

If there're several inverters parallelling operation in a plant, also it can use 1pcs meter to realize zero export function. For example, if there're 3pcs inverters parallelling operation in the system with 1pcs meter. We need to setup 1pcs inverter as the master and others setup as slaves. And, all of them need to connect to the meter via RS485. Below is the system diagram and configuration of the system.

MENU Setting			
Exp_Mode	AVG	Generator	ON
CT_Ratio	1	G.CT	1
MFR	AUTO	G.MFR	AUTO
FeedIn	0.0KW	G.Pout	0%
Shunt	OFF	G.Cap	200.0 KW
ShuntQTY	3		
	Back		

Pic 7.9 Meter function

Name	Description	Range
Exp_Mode	AVG: Average power of three phase is zero exported. MIN: Phase with minimum load power is zero exported, while the other two phase may be in purchase mode.	AVG/MIN
CT_Ratio	CT ratio of power grid side meter when extern CT is applied.	1-1000
MFR	Manufacturer of the grid side meter. Modbus Address of it should be set as 01.	AUTO/CHNT/ EASTRON
Feedin	Percentage of the Feed in power exported to the grid.	0-110%
Shunt	Parallel mode. Set one inverter as Master, others are Slave. ONLY need to set the master, Slave will follow the settings in the master.	OFF/Master/ Slave
ShuntQTY	Number of inverters in parallel	1-16
Generator	DG side meter function Enable/Disable	ON/OFF
G.CT	CT ratio of power DG side meter when extern CT is applied.	1-1000
G.MFR	Manufacturer of the DG side meter. Modbus Address of it should be set as 02.	AUTO/CHNT/ EASTRON
G.Pout	Output power percentage of the DG.	0-110%
G.Cap	Capacity of the DG.	1-999kW

Note: Select Meter option in Run Param and long press ENTER button to enter this Meter Setting page.

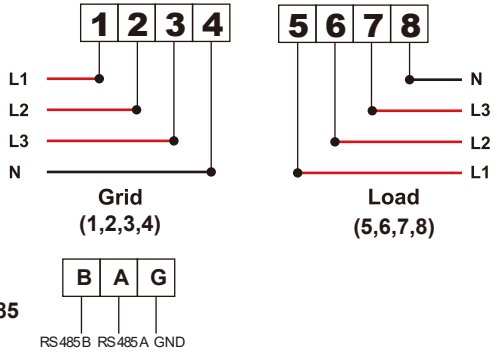

Eastron SDM630-Modbus V2 Pic 7.10 Eastron meter

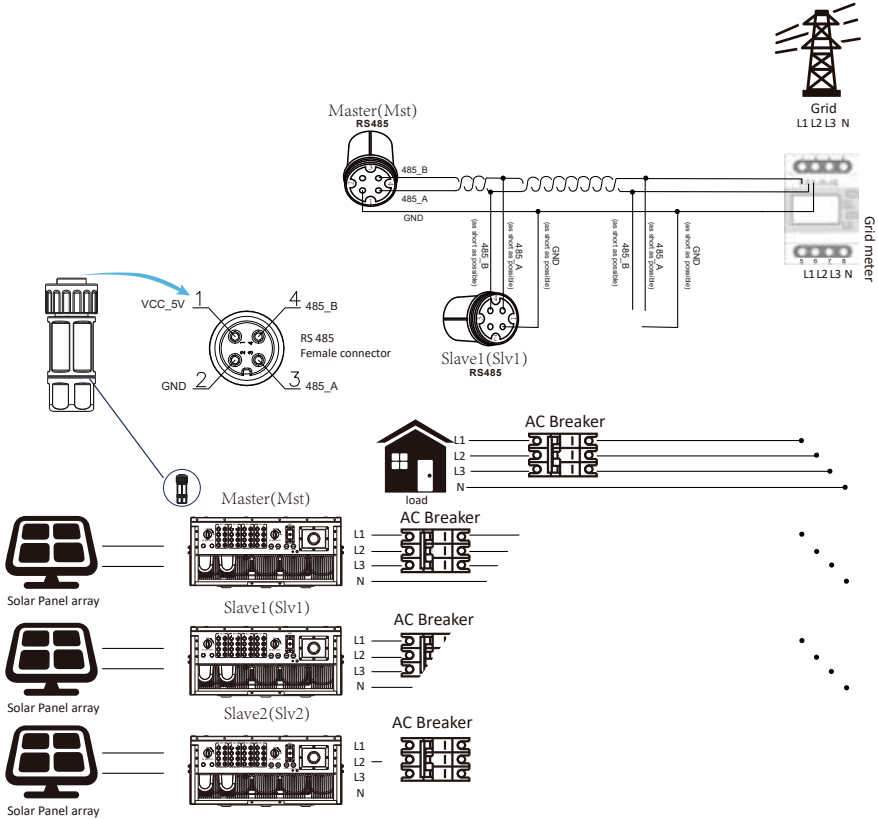

Pic 7.11 Eastron Connection diagram(The pass-through table)

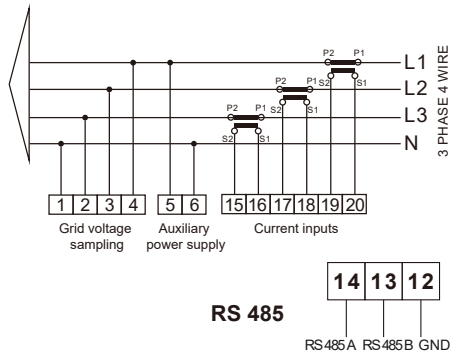
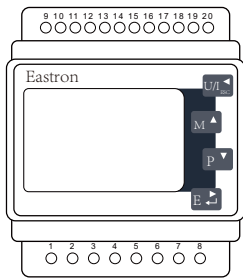

Eastron SDM630MCT

Pic 7.12 Eastron meter

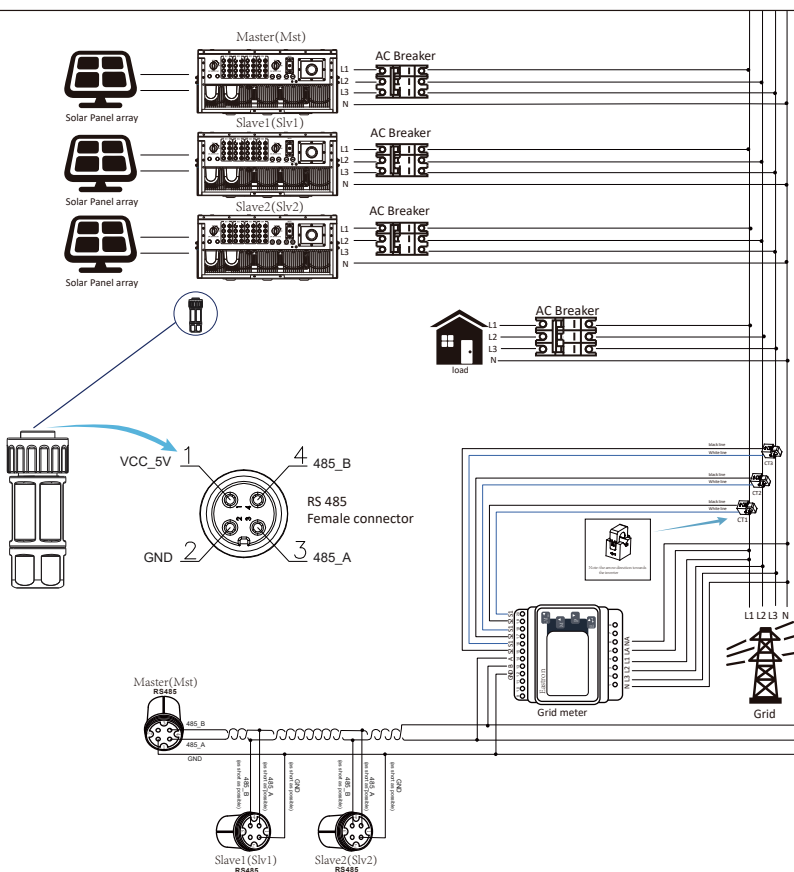

Pic 7.13 Connection diagram(Three-phase electricity)

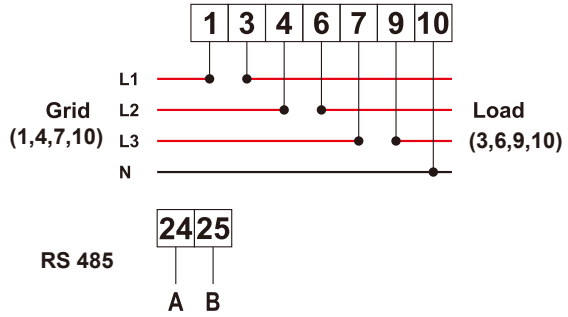
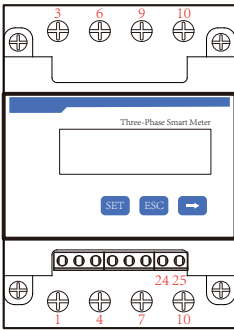

CHNT DTSU666

Pic 7.14 CHNT meter

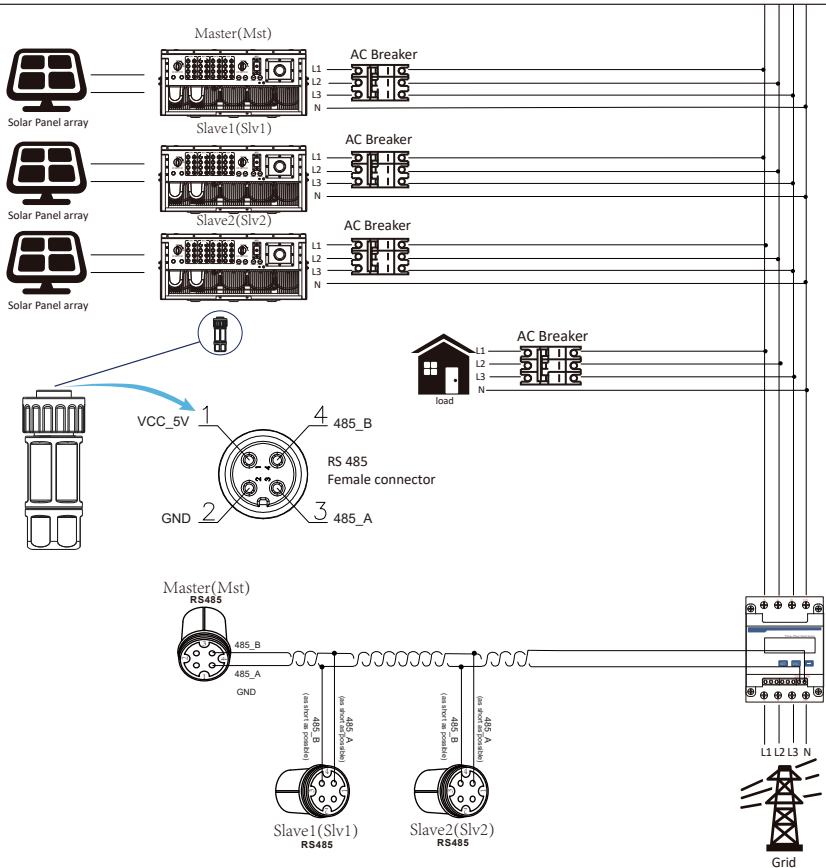

Pic 7.15 CHNT Connection diagram(The pass-through table)

7.2 How to browse the load power of your PV grid-tie plant on monitoring platform?

If you want to browse load power of the system and how much energy (KWH) does it export to grid (inverter output power is used to power the load firstly and then the surplus energy will feed into grid). You also need to connect the meter according to above diagram. After the connection completed successfully, the inverter will show the load power on the LCD. **But please don't setup "Meter ON"**. Also, you will be able to browse the load power on the monitoring platform. The plant setting method as below description.

Firstly, go to the solarman platform (<https://pro.solarmanpv.com>, this link is for solarman distributor account; or <https://home.solarmanpv.com>, this link is for solarman end user account;) plant home page and click "edit"

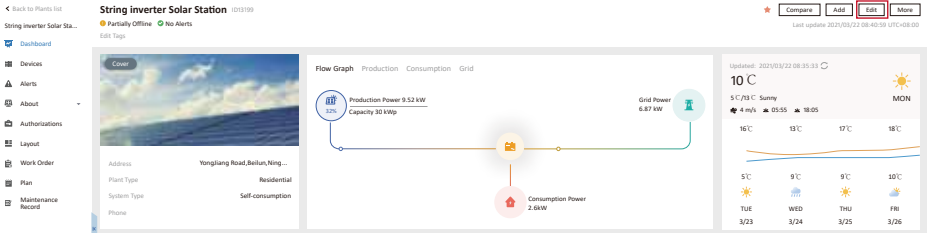

And then choose your system type as "Self-consumption"

The screenshot shows the "Edit Plant" form. It has a "Cancel" and "Save" button at the top right. The form is organized into sections: "Basic Info" (Address: Yongliang Road, Beijing, China), "System Info" (Coordinates, Longitude/Latitude, Time Zone: UTC+08:00 Beijing, Creation Time: 2020/04/08), and "Owner Info". In the "System Info" section, "Plant Type" is set to "Residential" and "System Type" is set to "Self-consumption" (highlighted with a red box). There is also a "Capacity (kWp)" field set to "30".

Secondly, go to plant page, if it shows the PV power, load power and grid power, which means the configuration is correct.

String Inverter Solar Station (201919)

Partially Offline No Alerts

Compare Add Edit More

Last update: 2023/09/22 08:35:33

Dashboard

Devices

Alerts

About

Authorizations

Layout

Work Order

Plan

Maintenance Record

Cover

Address: Hongliang Road, Beilun, Ning...

Plant Type: Residential

System Type: Self-consumption

Phone

Flow Graph Production Consumption Grid

Production Power 9.52 kW
Capacity 30 kWp
32%

Grid Power 6.87 kW

Consumption Power 2.6kW

Updated: 2023/09/22 08:35:33

10°C

5°C / 73°F Sunny 4 m/s

05:55 18:05 MON

16°C 13°C 17°C 18°C

5°C 9°C 9°C 10°C

TUE WED THU FRI

9/23 9/24 9/25 9/26

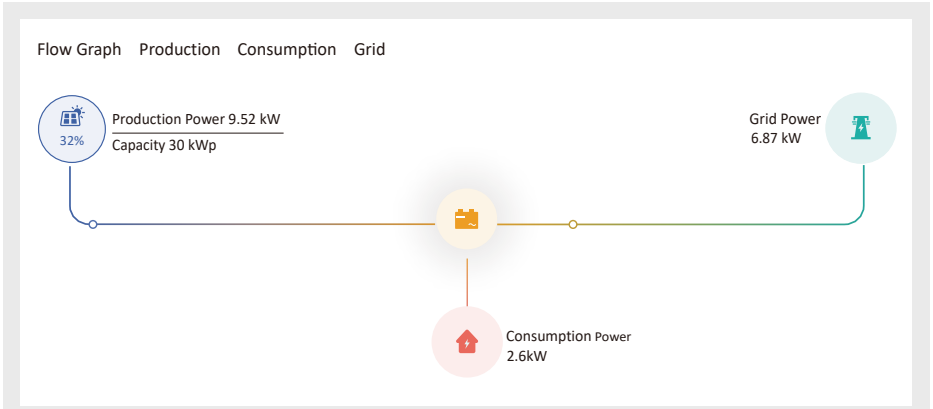

8. General Operation

During normal operation, the LCD shows the current status of the inverter, including the current power, total generation, a bar chart of power operation and inverter ID, etc. Press the Up key and the Down key to see the current DC voltage, DC current, AC voltage, AC current, inverter radiator temperature, software version number and Wifi connection state of the inverter.

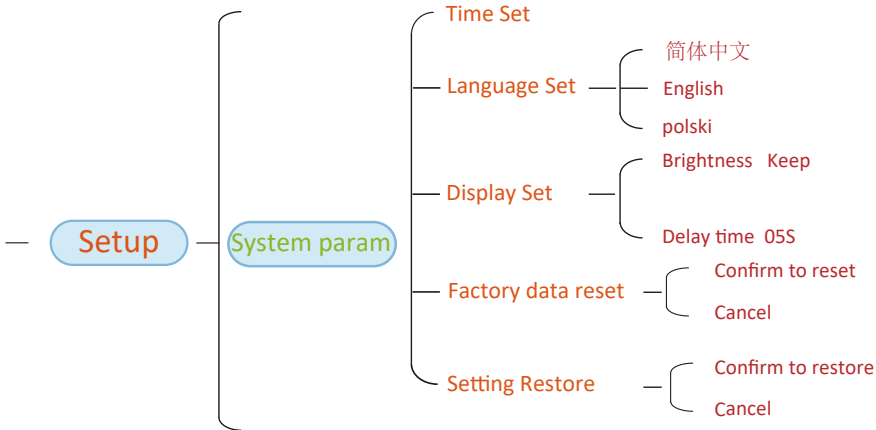
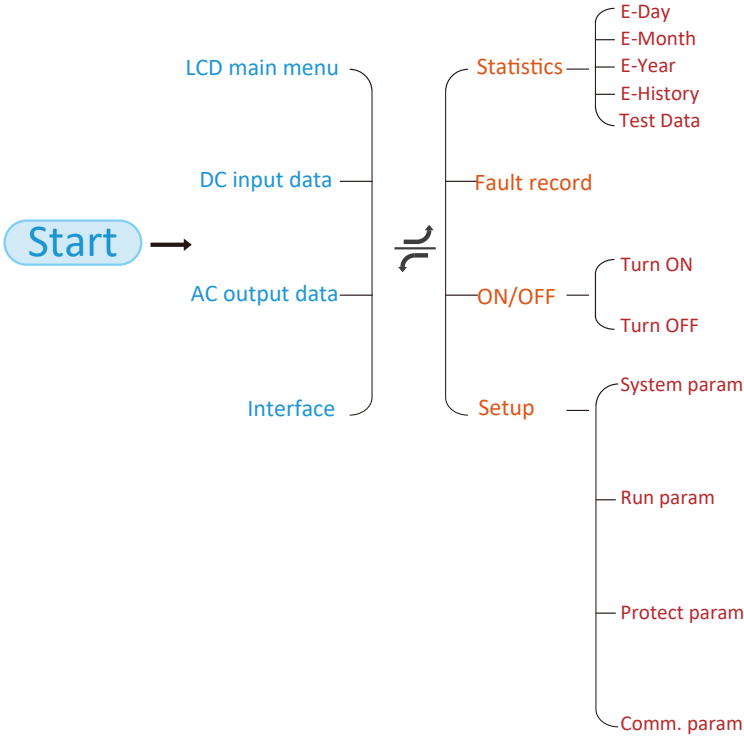

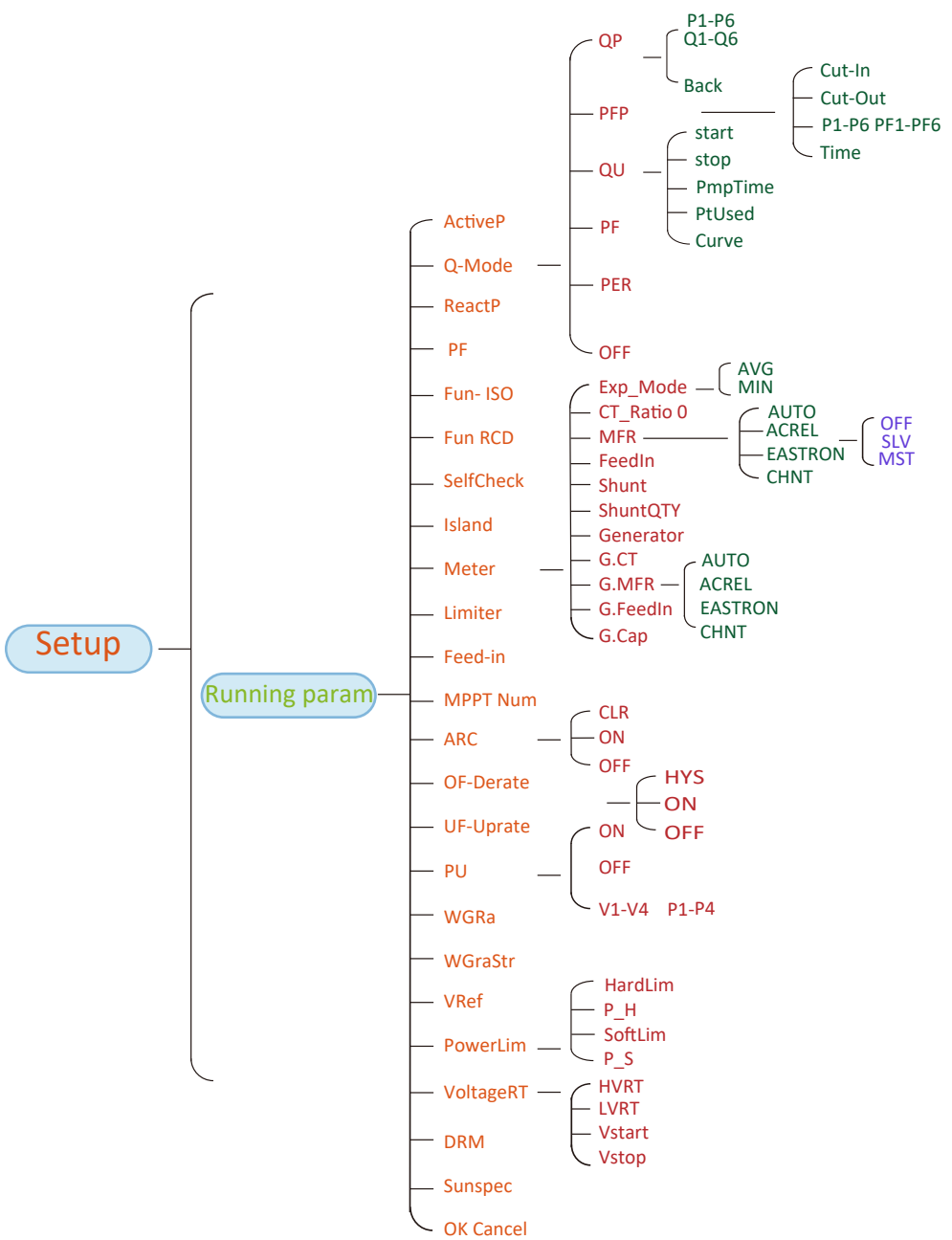

Setup

Protect Param

GridStandard

Advanced

Back

- INMETRO
- EN50549
- EN50438
- IEC61727
- CUSTOM
- VDE_4105
- UTE_C15
- RD1699
- CEI_0_21
- G98_G99
- AS4777(.2)
- NB/T 32004
- MEA
- PEA
- OV_3-OV_1 240.0V
- Tov_3-Tov_1 1000ms
- UV_1-UV_3 235.0V
- Tuv_1-Tuv_3 1000ms
- OF_3-OF_1 52.00HZ
- Tof_3-Tof_1 1000ms
- UF_1-UF_3 48.00HZ
- Tuf_1-Tuf_3 1000ms
- Vrc_H
- Vrc_L
- Frc_H
- Frc_L
- VGrid 127/220V
- OV10Min
- Uov

Comm. param

Address:08

Meter:Unkonw

BaudRate: 9600

8.1 The initial interface

From the initial interface, you can check power, daily generation, gross generation, inverter ID, model and time.

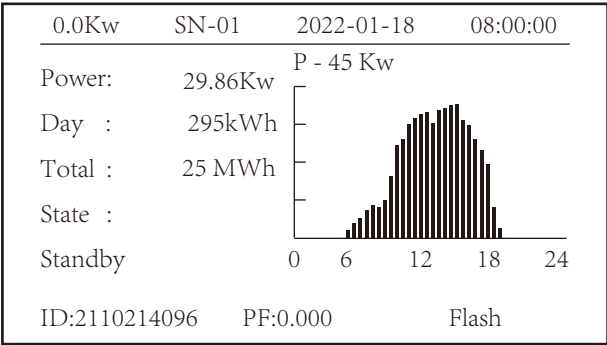

Pic 8.1 The initial interface

Press UP or Down you can check inverter DC voltage, DC current, AC voltage, AC current, inverter temperature, software version information.

RUN	Input		
PV1	V : 349.9V	I: 10.3A	P: 3.6KW
PV2	V : 313.0V	I: 8.3A	P: 2.6KW

Pic 8.2 PV input and DC current information

You can check the PV information, the number of strings input, MPPT voltage and MPPT current.

RUN	Grid
Ua : 234.5V	Ia : 0.0A
Grid Freq : 50.00Hz	

Pic 8.3 AC running state information

You can check the three phase voltage, current, and grid frequency.

RUN
Total DC Power:
3.602W
Lcd0196 Inv1400
● ●

Pic 8.4 Inverter firmware version

You can check the inverter LCD software Ver0196 and Control Software Version Ver1400. There are two black spot in the bottom right corner. The first flash means inverter is communicating with LCD. The second flash means LCD is communicating with wifi plug.

PARAMETR	Meter
	SN: 0
Meter Power: 0W	
Load Power: 0W	
Day	Total
ImpEp : 0.00kWh	0.00kWh
ExpEp : 0.00kWh	0.00kWh
LoadEp : 0.00kWh	0.00kWh

Pic 8.5 Meter power and load power

8.1.1 Main Menu

There are four submenu in the Main Menu.

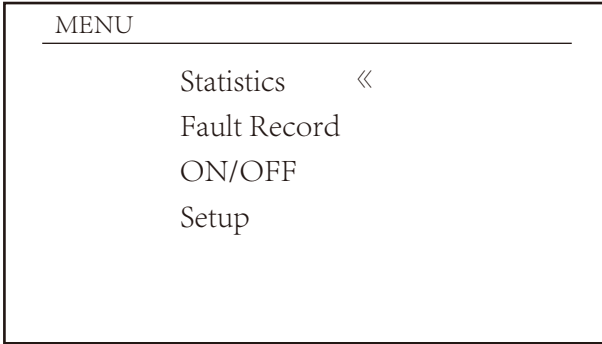

Pic 8.6 Main Menu

8.2 Statistics information

There are five submenu in the statistics.

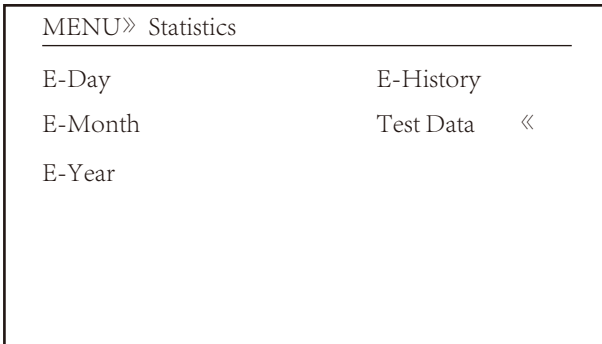

Pic 8.7 Statistics

Into each submenu through cursor.

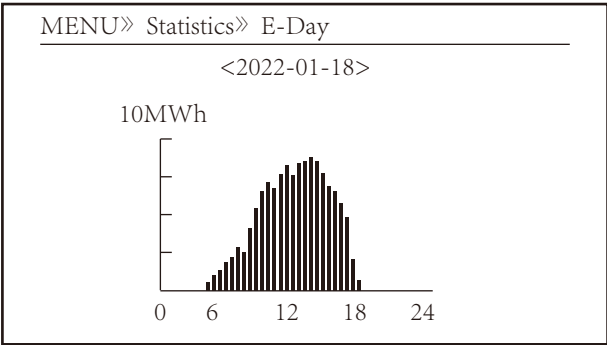

Pic 8.8 E-Day

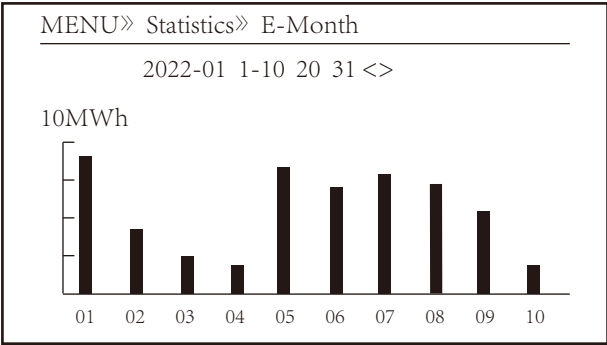

Pic 8.9 E-Month

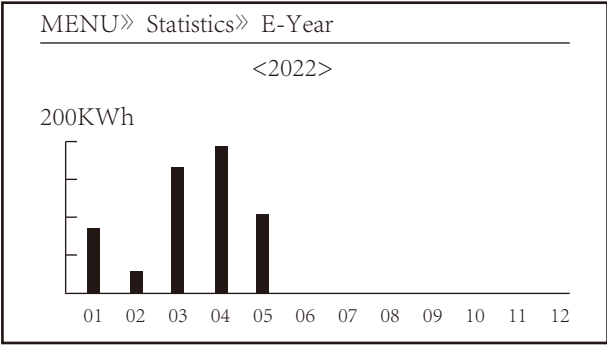

Pic 8.10 E-Year

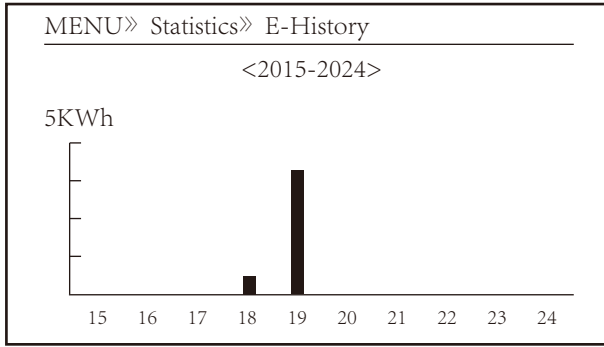

Pic 8.11 E-History

This information is for technician's reference.

PV1 :	19186	1k3 :	11126	ofC :	2057
PV2 :	19198	1k4 :	11140	137 :	2145
HV :	24362	1k5 :	16666	138 :	2248
GFD :	9119	1k6 :	2927	139 :	1497
DiL :	36	vHV :	24362	140 :	0
AVL :	-2	BSn :	12218	141 :	0
126 :	287	ofA :	2065	142 :	0
1k2 :	6	ofB :	2653	143 :	0
146 :	0	148 :	0	144 :	0
147 :	0	149 :	0	145 :	0

Pic 8.12 Test Data

8.3 Fault Record

Only can keep four fault record in the menu include time, customer can deal with it depends on the error code.

MENU» Fault Record

Fault :	F352022-01-05 08:38
History :	1 F352022-01-05 08:37
	2 F352022-01-04 18:47
	3 F352022-01-04 17:54
	4 F352022-01-04 17:53

Pic 8.13 Fault Record

8.4 ON/OFF setting

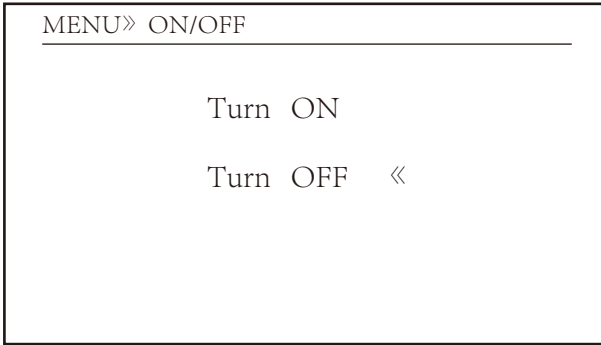

Pic 8.14 ON/OFF setting

Into each submenu through cursor.

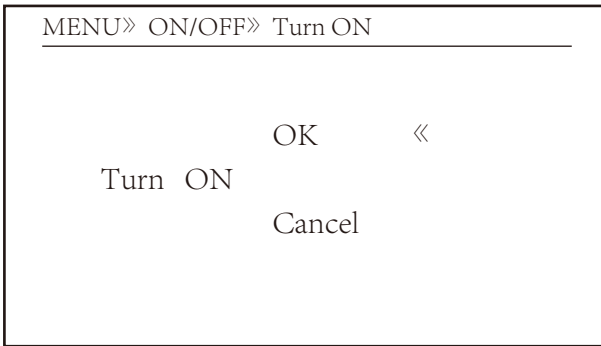

Pic 8.15 ON set

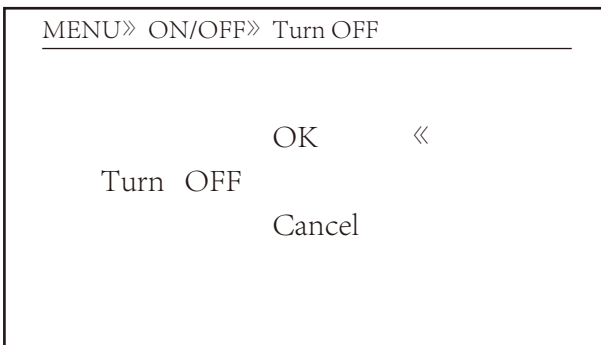

Pic 8.16 OFF set

8.5 Parameter setting

Setting includes system param, run param, protect param, comm.. param. All of these information for maintenance reference.

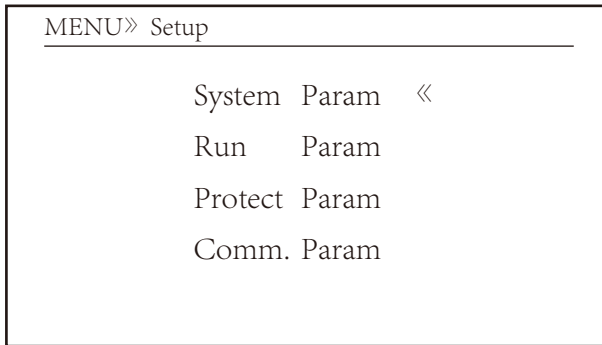

Pic 8.17 Setting

8.5.1 System Param

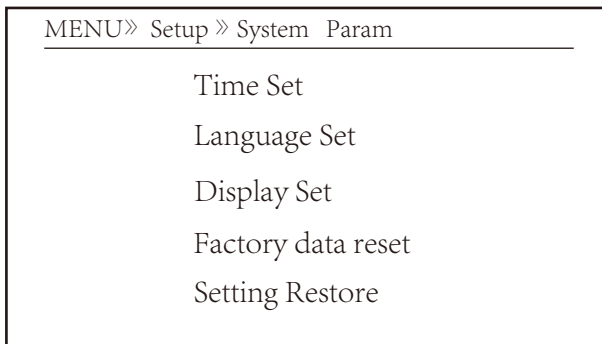

Pic 8.17.1 System Param Setting

8.5.1.1 Time Set

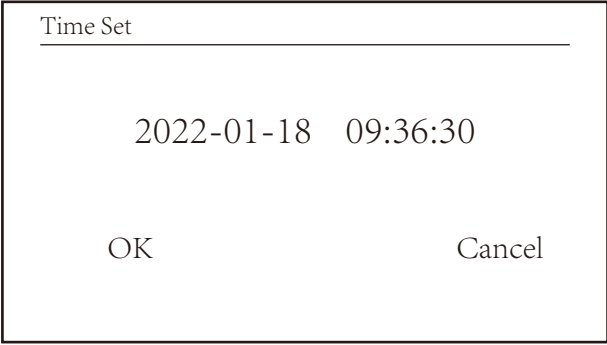

Pic 8.18 System Param

8.5.1.2 Language Set

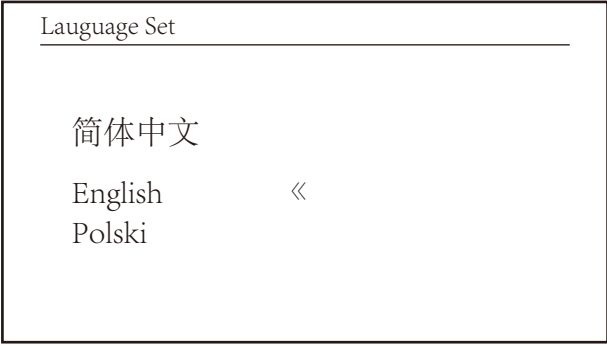

Pic 8.19 Language set

8.5.1.3 Display Set

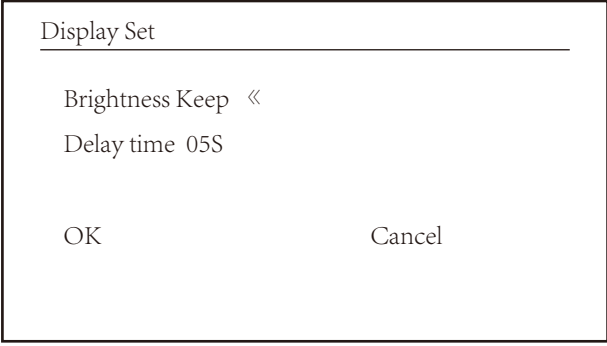

Pic 8.20 Display set

8.5.1.4 Factory data reset

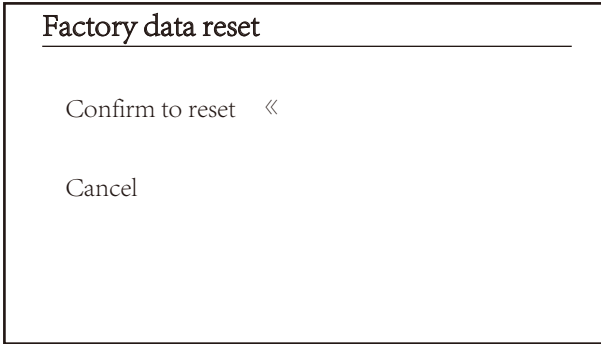

Pic 8.21 Factory data reset set

8.5.1.5 Setting Restore

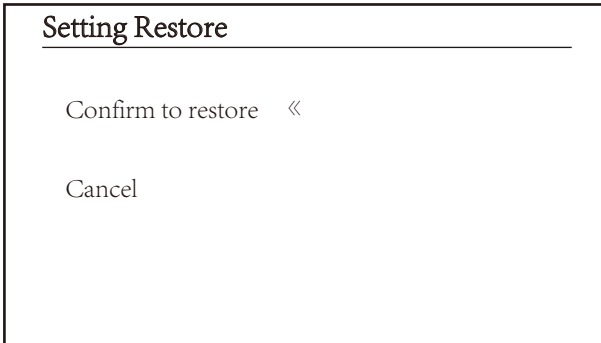

Pic 8.22 Factory data reset set



Warning:

Password required-- only for access-authorized engineer. Un-authorized access may avoid the warranty. The initial password is 1234.

8.5.2 Running Param



Pic 8.23 Password

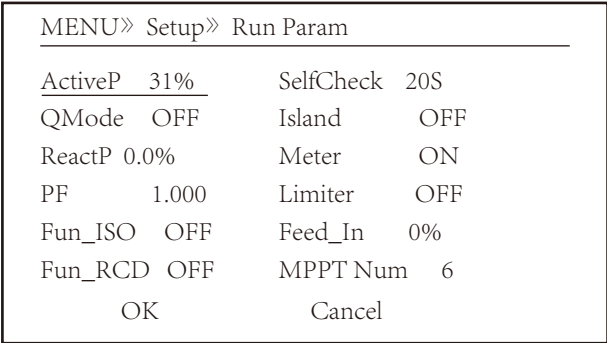

Name	Description	Range
ActiveP	Adjust the output active power in %	0-110%
QMode	Multiple reactive power control modes	OFF/Q(P)/PF(P) /Q(U)/PF/PER
ReactP	Adjust reactive power output in %	-100%~+100%
PF	Power Fator	-1-0.8~+0.8-1
Fun_ISO	Insulation resistance detection	ON/OFF
Fun_RCD	Residual current detection	ON/OFF
Self-check	Inverter's self-check time.The default value 60s	0-1000s
Island	Anti-islanding protection	ON/OFF
Meter	Energy meter.If inverter will connect meter,then set here to ON	ON/OFF
Feed_IN %	It is used to deploy how much power can be feed in to grid when the inverter works under zero export mode.(For example,Feed_in=50% of the 50KW model and load power is 24KW. which means Max 25KW power can be feed into grid after inverter providing 24Kw to the load firstly.	0-100%

Pic 8.24 Running Param



Warning:

Engineer Only.

We will set the param depends on the safety requirements, so customers don't need to reset it. The password is same as 8.23 Running param

MENU» Setup» Run Param			
ARC	OFF	Vref	0.0V
OFDerate	OFF	PowerLimit	
UFUprate	OFF	VoltageRT	
PU	OFF	DRM	OFF
WGra	0.0%	Sunspec	OFF
WGraStr	0.0%		
OK		Cancel	

Name	Description	Range
ARC	Arc-fault detection function	ON/OFF/Clear
OFDerate	Active power response to over frequency	0-100% Pmax/Hz
UFUprate	Active power response to under frequency	0-100% Pmax/Hz
PU	power response to grid voltage deviation	ON/OFF
WGra	Active power ramp rate (% Pnom/Sec)	0.1%-50%
WGraStr	Active power ramp rate at first start (% Pnom/Sec)	0.1%~50%
Vref	Grid reference voltage for functions including Q(U),PF(P),P(U)etc.	80-260V
PowerLimit	Hard/soft export limit control	ON/OFF
VoltageRT	voltage ride through function	ON/OFF
DRM	Demand Response Modes	ON/OFF
Sunspec	Sunspec Function	ON/OFF

8.5.2.1 Over-frequency Response

This series inverter provides “over-frequency response” function.

Long pressing the “OFDerate” to enter the “over-frequency response” setting menu.

MENU» Setup» Run Param			
ARC	OFF	Vref	220.0V
OFDerate	ON	PowerLimit	
UFUprate	OFF	VoltageRT	
PU	OFF	DRM	OFF
WGra	20.0%	Sunspec	OFF
Sunspec	OFF		
	OK	Cancel	

Definition of Over-frequency Response Parameters

Parameter	Range	Description
StartPoint	45HZ-65HZ	The Start frequency value for over-frequency response.
StopPoint	45HZ-65HZ	The Stop frequency value for over-frequency response.
RecoverPoint	45HZ-65HZ	In hysteresis mode, power is restored only when it is below this frequency
RecoverGradient	0.3%~300% P/min	Ramp rate of power recovery
RecoverDelay	0-1000s	Time Delay of power recovery in hysteresis mode

For example, StartPoint: 50.5Hz, StopPoint: 51.5Hz, RecoverPoint: 50.1Hz, when the grid frequency increases beyond StartPoint: 50.5Hz, the inverter will linearly reduce the power output with a gradient of 100% Pmax/Hz until it reaches StopPoint: 51.5Hz.

OverFrequencyDerate	
StartPoint	50.50Hz
StopPoint	51.50Hz
RecoverPoint	50.1Hz
RecoverGradient	1.00%
RecoverDelay	0S
	Back

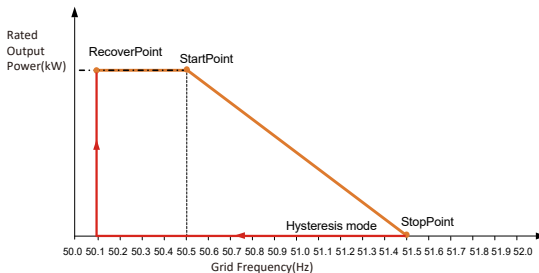

Frq-Watt Mode for Over-frequency Conditions

When the frequency exceeds StopPoint: 51.5Hz, the inverter output should stop (ie 0 W).
 When the frequency is lower than StopPoint: 51.5 Hz, the inverter will linearly increase the power output with a gradient of 100% Pmax/Hz until it reaches StopPoint: 50.5 Hz.
 In the hysteresis mode, when the frequency is lower than StopPoint: 51.5 Hz, the inverter will not increase the power output until it is lower than RecoverPoint: 50.1 Hz.

MENU» Setup» Run Param			
ActiveP	31%	SelfCheck	20S
QMode	QU	Island	OFF
ReactP	0.0%	Meter	ON
PF	1.000	Limiter	OFF
Fun_ISO	ON	Feed_In	0%
Fun_RCD	ON	MPPT Num	6
	OK		Cancel

The inverter provides a reactive power regulation function.
 Tap **Reactive Power Regulation Mode** to select proper regulation mode and set the corresponding parameters.

- **"OFF" Mode**
 The reactive power regulation function is disabled. The PF is fixed at +1.000
- **ReactiveP**
 Adjust reactive power output in %.
- **"PF" Mode**
 The power factor (PF) is fixed and the reactive power is regulated by the parameter PF. The PF ranges from 0.8 leading to 0.8 lagging.
 - Leading: the inverter is absorbing reactive power from the Grid.
 - Lagging: the inverter is injecting reactive power into the grid.
- **"Q(U)" Mode**
 The reactive power output of the inverter varies in response to the grid voltage.
- **"Q(P)" Mode**
 The reactive power output by the inverter is controlled by the active power of the inverter.

“Q(U)” Mode

QU Setting	
Start	30.0%
Stop	20.0%
RmpTime	2s
PtUsed	4
Curve	_____
Back	

QU Setting			
V1	80.0%	Q1	-25.0%
V2	90.0%	Q2	0.0%
V3	110.0%	Q3	0.0%
V4	120.0%	Q4	25.0%
V5	120.0%	Q5	25.0%
V6	120.0%	Q6	25.0%
Back			

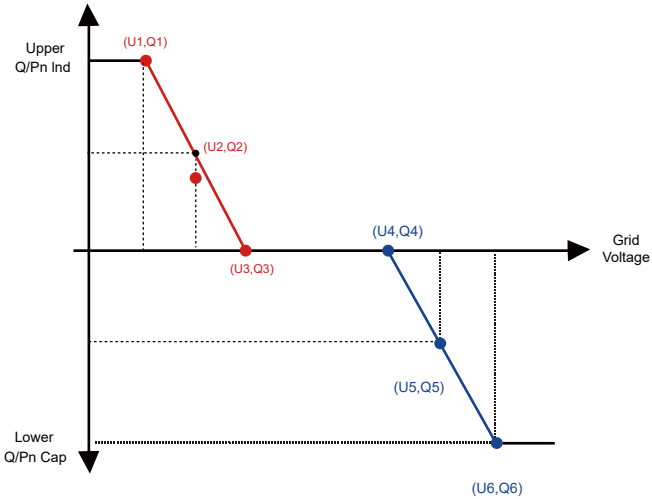

Pic 8.25 Reactive Power Regulation Curve in Q(U) Curve

Parameter	Range	Description
Start	0%-130% Rate out power	The QU mode starts when the active power is greater than this value
Stop	0%-130% Rate out power	The QU mode stops when the active power is less than this value
RMpTime	0-1000s	Increase or decrease the time required for the reactive power to reach the specified value of the curve.
PtUsed	2-6	Point number used in QU Curve
Curve		QU Curve
Q1	-60% -60% Q/Pn	Value of Q/Pn at point (U1,Q1) on the Q(U) mode curve
V1	0-110% VRated	Grid voltage limit at point (U1,Q1) on the Q(U) mode curve
Q2	-60% -60% Q/Pn	Value of Q/Pn at point (U2,Q2) on the Q(U) mode curve
V2	0-110% VRated	Grid voltage limit at point (U2,Q2) on the Q(U) mode curve
Q3	-60% -60% Q/Pn	Value of Q/Pn at point (U3,Q3) on the Q(U) mode curve
V3	0-110% VRated	Grid voltage limit at point (U3,Q3) on the Q(U) mode curve
Q4	-60% -60% Q/Pn	Value of Q/Pn at point (U4,Q4) on the Q(U) mode curve
V4	0-110% VRated	Grid voltage limit at point (U4,Q4) on the Q(U) mode curve
Q5	-60% -60% Q/Pn	Value of Q/Pn at point (U5,Q5) on the Q(U) mode curve
V5	0-110% VRated	Grid voltage limit at point (U5,Q5) on the Q(U) mode curve
Q6	-60% -60% Q/Pn	Value of Q/Pn at point (U6,Q6) on the Q(U) mode curve
V6	0-110% VRated	Grid voltage limit at point (U6,Q6) on the Q(U) mode curve

"Q(U)" Mode Parameters Explanation

“Q(P)” Mode

The reactive power output by the inverter is controlled by the active power of the inverter.

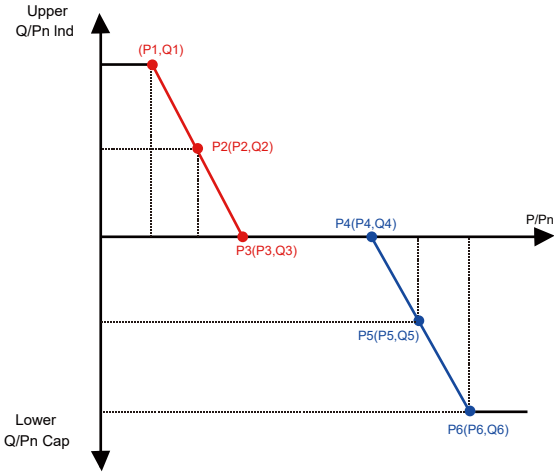

Pic 8.26 Reactive Power Regulation Curve in Q(P) Mode

MENU» Setup» Run Param			
ActiveP	31%	SelfCheck	20S
QMode	QP	Island	OFF
ReactP	0.0%	Meter	ON
PF	1.000	Limiter	OFF
Fun_ISO	ON	Feed_In	0%
Fun_RCD	ON	MPPT Num	6
OK		Cancel	

QP Setting			
P1	80.0%	Q1	-25.0%
P2	90.0%	Q2	0.0%
P3	110.0%	Q3	0.0%
P4	120.0%	Q4	25.0%
P5	120.0%	Q5	25.0%
P6	120.0%	Q6	25.0%
Back			

Parameter	Range	Description
P1	0%-100% Pn	Value of Q/Pn at point (P1,Q1) on the Q(P) mode curve
Q1	-60% -60% Q/Pn	Reactive power value at point (P1,Q1) on the Q(P) mode curve
P2	0%-100% Pn	Value of Q/Pn at point (P2,Q2) on the Q(P) mode curve
Q2	-60% -60% Q/Pn	Reactive power value at point (P2,Q2) on the Q(P) mode curve
P3	0%-100% Pn	Value of Q/Pn at point (P3,Q3) on the Q(P) mode curve
Q3	-60% -60% Q/Pn	Reactive power value at point (P3,Q3) on the Q(P) mode curve
P4	0%-100% Pn	Value of Q/Pn at point (P4,Q4) on the Q(P) mode curve
Q4	-60% -60% Q/Pn	Reactive power value at point (P4,Q4) on the Q(P) mode curve
P5	0%-100% Pn	Value of Q/Pn at point (P5,Q5) on the Q(P) mode curve
Q5	-60% -60% Q/Pn	Reactive power value at point (P5,Q5) on the Q(P) mode curve
P6	0%-100% Pn	Value of Q/Pn at point (P6,Q6) on the Q(P) mode curve
Q6	-60% -60% Q/Pn	Reactive power value at point (P6,Q6) on the Q(P) mode curve

"Q(P)" Mode Parameters Explanation

"PU" Mode

The active power output of the inverter varies in response to the grid voltage

MENU» Setup» Run Param			
ARC	OFF	Vref	0.0V
OFDerate	OFF		
UFUprate	OFF		
PU	ON		
WGra	0.0%		
Sunspec	OFF		
	OK	Cancel	

PU Setting			
U1	0.0%	P1	0.0%
U2	0.0%	P2	0.0%
U3	0.0%	P3	0.0%
U4	0.0%	P4	0.0%

Back

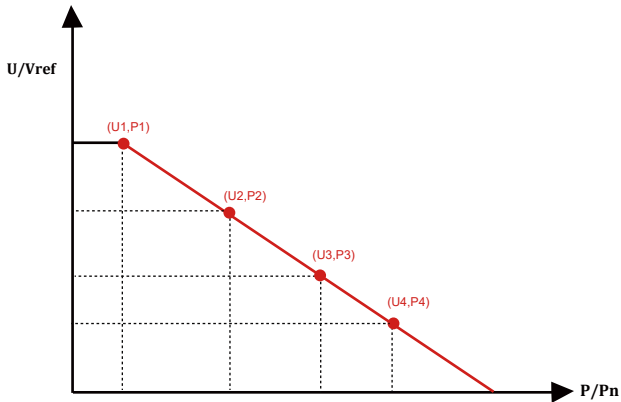

Pic 8.27 Active Power Regulation Curve in PU Curve

Parameter	Range	Description
P1	0%-110% Pn	Value of P/Pn at point (P1,U1) on the PU mode curve
U1	0% -150% Vref	Grid voltage limit at point (P1,U1) on the PU mode curve
P2	0%-110% Pn	Value of P/Pn at point (P2,U2) on the PU mode curve
U2	0% -150% Vref	Grid voltage limit at point (P2,U2) on the PU mode curve
P3	0%-110% Pn	Value of P/Pn at point (P3,U3) on the PU mode curve
U3	0% -150% Vref	Grid voltage limit at point (P3,U3) on the PU mode curve
P4	0%-110% Pn	Value of P/Pn at point (P4,U4) on the PU mode curve
U4	0% -150% Vref	Grid voltage limit at point (P4,U4) on the PU mode curve

"PU" Mode Parameters Explanation

“PF(P)” Mode

PFP Setting			
Vstart	0.0%	Vstop	0.0%
P1	0.0%	PF1	-1.000
P2	0.0%	PF2	-1.000
P3	0.0%	PF3	-1.000
P4	0.0%	PF4	-1.000
P5	0.0%	PF5	-1.000
Back			

PFP Setting			
P6	0.0%	PF6	-1.000
Time	0s		
Back			

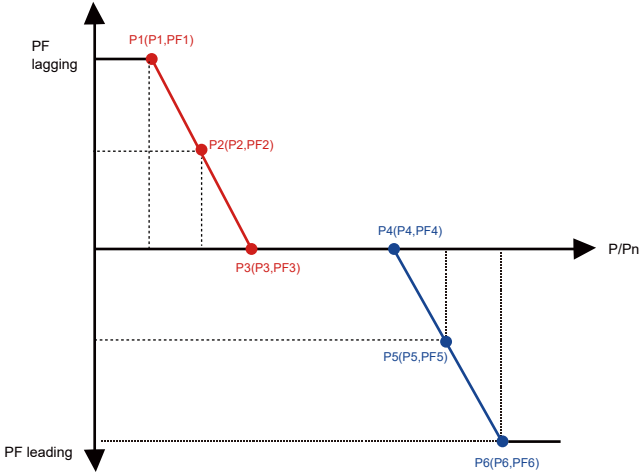

Pic 8.28 Power factor Regulation Curve in PF(P) Mode

Parameter	Range	Description
Vstart	0-150% Vref	The PFP mode is enable when grid voltage is greater than Vstart
Vstop	0-150% Vref	The PFP mode is disable when grid voltage is less than Vstop
P1	0-110% Pn	Power value at point (PF1,P1) on the PF(P) Curve
PF1	0.8 leading - 0.8 lagging	PF value at point (PF1,P1) on the PF(P) Curve
P2	0-110% Pn	Power value at point (PF2,P2) on the PF(P) Curve
PF2	0.8 leading - 0.8 lagging	PF value at point (P2,PF2) on the PF(P) Curve
P3	0-110% Pn	Power value at point (P3,PF3) on the PF(P) Curve
PF3	0.8 leading - 0.8 lagging	PF value at point (P3,PF3) on the PF(P) Curve
P4	0-110% Pn	Power value at point (P4,PF4) on the PF(P) Curve
PF4	0.8 leading - 0.8 lagging	PF value at point (P4,PF4) on the PF(P) Curve
P5	0-110% Pn	Power value at point (P5,PF5) on the PF(P) Curve
PF5	0.8 leading - 0.8 lagging	PF value at point (P5,PF5) on the PF(P) Curve
P6	0-110% Pn	Power value at point (P6,PF6) on the PF(P) Curve
PF6	0.8 leading - 0.8 lagging	PF value at point (P6,PF6) on the PF(P) Curve
RMpTime	0-1000s	The time of the PFF Curve in seconds (time to accomplish a change of 95%).

"PF(P)" Mode Parameters Explanation

8.5.3 Protect Param

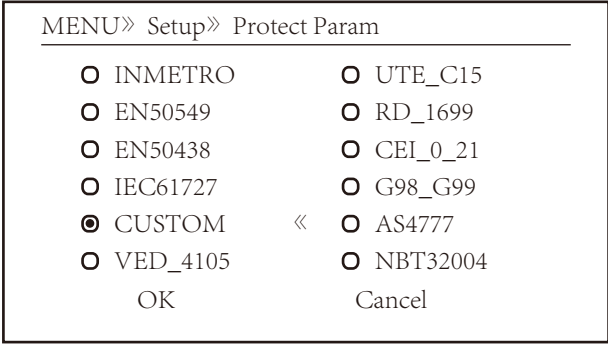

Pic 8.29 Protect Param



Warning:
Engineer only.

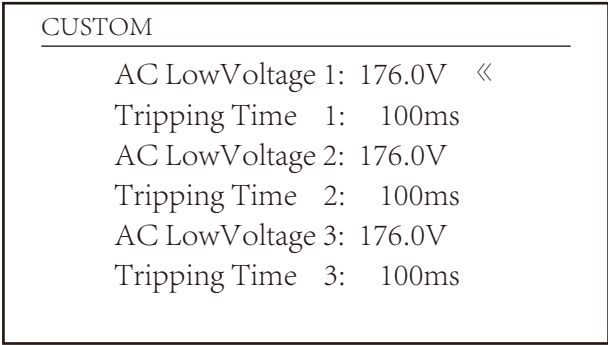
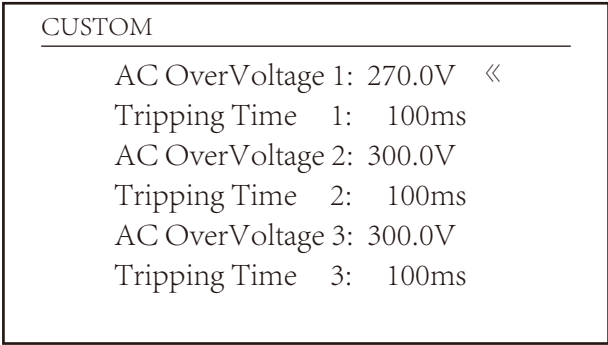

CUSTOM

AC OverFreq 1: 52.00Hz «
Tripping Time 1: 2000ms
AC OverFreq 2: 53.00Hz
Tripping Time 2: 500ms
AC OverFreq 3: 54.00Hz
Tripping Time 3: 200ms

CUSTOM

AC LowFreq 1: 48.00Hz «
Tripping Time 1: 2000ms
AC LowFreq 2: 47.00Hz
Tripping Time 2: 500ms
AC LowFreq 3: 46.00Hz
Tripping Time 3: 200ms

CUSTOM

Rated Voltage 220/380V «

OK Cancel

Pic 8.25 "CUSTOM"

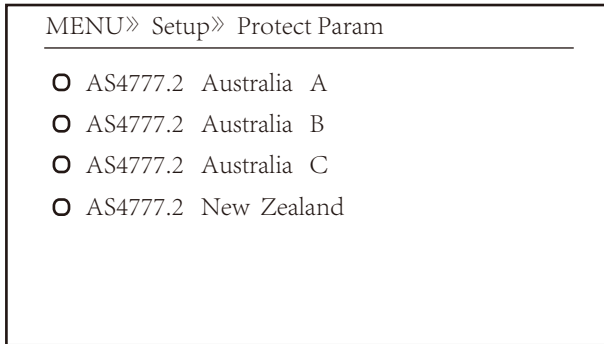
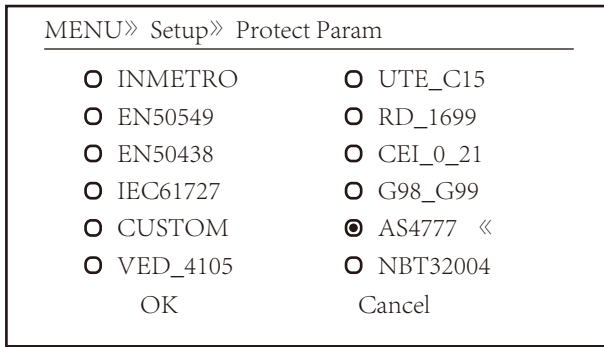

Pic 8.30 "AS4777"

8.5.4 Comm. Param

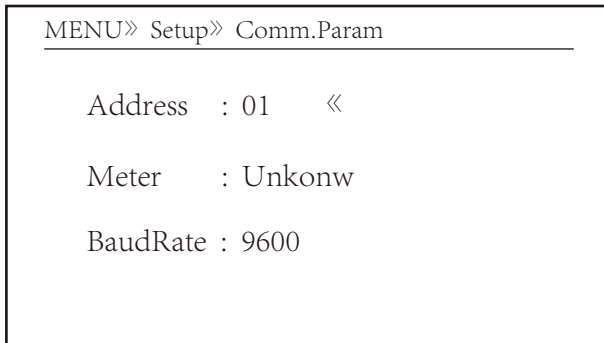

Pic 8.31 Communication param

9. Repair and Maintenance

String type inverter doesn't need regular maintenance. However, debris or dust will affect heat sink's thermal performance. It is better to clean it with a soft brush. If the surface is too dirty and affect the reading of LCD and LED lamp, you can use wet cloth to clean it up.



High Temperature Hazard:

When the device is running, the local temperature is too high and the touch can cause burns. Turn off the inverter and wait for it cooling, then you can clean and maintain.



Safety Hint:

No solvent, abrasive materials or corrosive materials can be used for cleaning any parts of the inverter.

10. Error information and processing

Inverter has been designed in accordance with international grid tied standards for safety, and electromagnetic compatibility requirements. Before delivering to the customer the inverter has been subjected to several tests to ensure its optimal operation and reliability.

10.1 Error code

If there is any failure, the LCD screen will display an alarm message. In this case, the inverter may stop feeding energy into the grid. The alarm description and their corresponding alarm messages are listed Table 10.1.

Error code	Description	Ongrid - Three Phase
F01	DC input polarity reverse fault	Check the PV input polarity.
F02	DC insulation impedance permanent fault	Check the grounding cable of inverter.
F03	DC leakage current fault	Hardly appear the code. Never ever happened so far.
F04	Ground fault GFDI	Check the solar panel output connection.
F05	Read the memory error	Failure in reading memory (EEPROM). Restart the inverter if the fault still exists, contact your installer or Deye service.
F06	Write the memory error	Failure in writing memory (EEPROM). Restart the inverter if the fault still exists, contact your installer or Deye service.
F07	GFDI blown fuse	Hardly appear the code. Never ever happened so far.
F08	GFDI grounding touch failure	Hardly appear the code. Never ever happened so far.
F09	IGBT damaged by excessive drop voltage	Hardly appear the code. Never ever happened so far.
F10	Auxiliary switch power supply failure	1. It tells the DC 12V is not existed. 2. Restart the inverter, if the fault still exists, please contact your installer.
F11	AC main contactor errors	Hardly appear the code. Never ever happened so far.
F12	AC auxiliary contactor errors	Hardly appear the code. Never ever happened so far.
F13	reserved	1. Loss of one phase or AC voltage detection part failure or relays not closed. 2. Restart the inverter, if the error still exists, please contact your installer or Deye service.
F14	DC firmware over current	Hardly appear the code. Never ever happened so far.
F15	AC firmware over current	1. The internal AC sensor or detection circuit on control board or connection wire may loose. 2. Restart the inverter, if the error still exists, please contact your installer or Deye service.
F16	GFCI(RCD) Ac leakage current fault	1. This fault means the average leakage current is over 300mA. Check whether DC power supply or solar panels is ok, then check 'Test data'-> 'dil' value is about 40; Then check the leakage current sensor or circuit (the following picture). Checking test data needs using big LCD. 2. Restart the inverter, if the error still exists, please contact your installer or Deye service.
F17	Three phase current, over-current fault	Hardly appear the code. Never ever happened so far.
F18	AC over current fault of hardware	1. Check AC sensor or detection circuit on control board or connection wire. 2. Restart the inverter or factory reset, if the error still exists, please contact your installer or Deye service.
F19	All hardware failure synthesis	Hardly appear the code. Never ever happened so far.
F20	DC over current fault of the hardware	1. Check whether solar panel output current is within the allowed range. 2. Check DC current sensor and its detection circuit. 3. Check if the inverter FW version is suitable for the hardware. 4. Restart the inverter, if the error still exists, please contact your installer or Deye service.

Error code	Description	Ongrid - Three Phase
F21	DC leakage flow fault	Hardly appear the code. Never ever happened so far.
F22	Crash stop (if there is a stop button)	Contact your installer for help.
F23	AC leakage current is transient over current	<ol style="list-style-type: none"> 1. This fault means the leakage current is above 30mA suddenly. Check whether DC power supply or solar panels is ok, then check 'Test data'-> 'dil' value is about 40; Then check the leakage current sensor or circuit. Check test data needs using big LCD. 2. Restart the inverter, if the fault still exists, contact your installer or Deye service.
F24	DC insulation impedance failure	<ol style="list-style-type: none"> 1. Check Vpe resistance on main board or detection on control board. Check PV panels is OK. Many times this issue is the PV problem. 2. Check whether the PV panel (aluminum frame) is grounded well and inverter is grounded well. Open the cover of inverter and then check the inside ground cable is fixed well on the shell. 3. Check if the AC/DC cable, terminal block are shorted to ground or the insulation is damaged. 4. Restart the inverter, if the fault still exists, contact your installer or Deye service.
F25	DC feedback fault	Hardly appear the code. Never ever happened so far.
F26	The DC busbar is unbalanced	<ol style="list-style-type: none"> 1. Check whether the 'BUSN' cable or driver board power supply cable is loose. 2. Restart the inverter, if the fault still exists, contact your installer or Deye service.
F27	DC end insulation error	Hardly appear the code. Never ever happened so far.
F28	Inverter 1 DC high fault	Hardly appear the code. Never ever happened so far.
F29	AC load switch failure	Hardly appear the code. Never ever happened so far.
F30	AC main contactor failure	<ol style="list-style-type: none"> 1. Check relays and AC voltage of relays. 2. Check relays driver circuit. Check if the software is not suitable for this inverter. (Old inverter not have relays detection function) 3. Restart the inverter, if the fault still exists, contact your installer or Deye service.
F31	Relay open circuit fault	<ol style="list-style-type: none"> 1. At least one Relay can't be closed. Check relays and its driver signal. (Old inverter not have relays detection function) 2. Restart the inverter, if the fault still exists, contact your installer or Deye service.
F32	Inverter 2 dc high fault	Hardly appear the code. Never ever happened so far.
F33	AC over current	Hardly appear the code. Never ever happened so far.
F34	AC current over load	Hardly appear the code. Never ever happened so far.
F35	No AC grid	<ol style="list-style-type: none"> 1. Check AC grid voltage. Check AC voltage detection circuit. Check if the AC connector in good condition. Check whether the AC grid is normal in voltage. 2. Restart the inverter, if the fault still exists, contact your installer or Deye service.
F36	AC grid phase error	Hardly appear the code. Never ever happened so far.
F37	AC three-phase voltage unbalance failure	Hardly appear the code. Never ever happened so far.
F38	AC three-phase current unbalance failure	Hardly appear the code. Never ever happened so far.

Error code	Description	Ongrid - Three Phase
F39	AC over current(one cycle)	1. Check AC current sensor and its circuit. 2. Restart the inverter, if the fault still exists, contact your installer or Deye service.
F40	DC over current	Hardly appear the code. Never ever happened so far.
F41	AC Line W,U over voltage	Check the AC voltage protection setting. And Check if the AC cable is too thin.Check the voltage difference between LCD and meter.
F42	AC Line W,U low voltage	Check the AC voltage protection setting. Check the voltage difference between LCD and meter. Also need to check whether AC cables are all firmly and correctly connected.
F43	AC Line V,W over voltage	Check the AC voltage protection setting.And Check if the AC cable is too thin.Check the voltage difference between LCD and meter.
F44	AC Line V,W low voltage	Check the AC voltage protection setting. Check the voltage difference between LCD and meter. Also need to check whether AC cables are all firmly and correctly connected.
F45	AC Line U,V over voltage	Check the AC voltage protection setting.And Check if the AC cable is too thin.Check the voltage difference between LCD and meter.
F46	AC Line U,V low voltage	Check the AC voltage protection setting.
F47	AC Over frequency	Check the frequency protection setting.
F48	AC lower frequency	Check the frequency protection setting.
F49	U phase grid current DC component over current	Hardly appear the code. Never ever happened so far.
F50	V phase grid current DC component over current	Hardly appear the code. Never ever happened so far.
F51	W phase grid current DC component over current	Hardly appear the code. Never ever happened so far.
F52	AC inductor A, phase current DC current high	Hardly appear the code. Never ever happened so far.
F53	AC inductor B, phase current DC current high	Hardly appear the code. Never ever happened so far.
F54	AC inductor C, phase current DC current high	Hardly appear the code. Never ever happened so far.
F55	DC busbar voltage is too high	1. Check PV voltage and Ubus voltage and its detection circuit. If the PV input voltage exceeds the limit, please reduce the number of solar panels in series. 2. For Ubus voltage, please check the LCD display.
F56	DC busbar voltage is too low	1. It tells the PV input voltage is low and it always happens in the early morning. 2. Check PV voltage and Ubus voltage. When inverter is running, then showing F56, maybe Loss of driver or need update firmware. 3. Restart the inverter, if the fault still exists, contact your installer or Deye service.
F57	AC reverse irrigation	AC reverse irrigation.
F58	AC grid U over current	Hardly appear the code. Never ever happened so far.

Error code	Description	Ongrid - Three Phase
F59	AC grid V over current	Hardly appear the code. Never ever happened so far.
F60	AC grid W over current	Hardly appear the code. Never ever happened so far.
F61	Reactor A phase over current	Hardly appear the code. Never ever happened so far.
F62	Reactor B phase over current	Hardly appear the code. Never ever happened so far.
F63	ARC fault	1. Check PV module cable connection and clear the fault; 2. Seek help from us, if can not go back to normal state.
F64	IGBT heat sink high temperature	1. Check temperature sensor. Check if firmware is suitable for the hardware. Check if the inverter is its right model. 2. Restart the inverter, if the fault still exists, contact your installer.

Table10.1 Error codes and their solutions



Safety Hint:

If your string inverter has any of the fault information shown in Table 10-1, and when you reset the machine and still don't solve the problem, please contact our distributor and provide the below details:

1. Serial number of the inverter;
2. The distributor/dealer of the inverter(if available);
3. Installation date;
4. The discription of problem(include LCD'error code and LED status indicator lights);
5. Your contact details.

11.Specification

Model	SUN-35K-G02-LV SUN-40K-G-LV SUN-45K-G-LV SUN-50K-G-LV			
Input Side				
Max.DC Power(kW)	45.5	52	58.5	65
Max.DC Input Voltage(V)	800			
Start-up DC Input Voltage(V)	250			
MPPT Operating Range(V)	200~700			
Max.DC Input Current(A)	30+30+30+30	40+40+40+40		
Max. Short Circuit Current (A)	45+45+45+45	60+60+60+60		
Number of MPPT/Strings per MPPT	4/3	4/4		
MAX inverter backfeed current (A)	0			
Output Side				
Rated Output Power(kW)	35	40	45	50
Max.Active Power(kW)	38.5	44	49.5	55
Rated AC Grid Voltage(V)	3L/N/PE 127/220V			
AC Grid Voltage Range(V)	0.85Un-1.1Un (this may vary with grid standards)			
Rated Grid Frequency(Hz)	50 / 60 (Optional)			
Operating Phase	Three phase			
Rated AC Grid Output Current(A)	91.9	104.9	118.1	131.2
Max.AC Output Current(A)	101.1	115.5	129.9	144.4
Maximum output fault current (a.c. A, peak)	175.4	200.2	225.4	250.4
Maximum output overcurrent protection (a.c. A,peak)	194.9	222.5	250.5	278.3
Output Power Factor	0.8 leading to 0.8 lagging			
Grid Current THD	<3%			
DC Injection Current(mA)	<0.5%			
Grid Frequency Range	47-52 or 57-62 (Optional)			
Efficiency				
Max.Efficiency	98.7%			
Euro Efficiency	98.3%			
MPPT Efficiency	>99%			
General Data				
Size(mm, W×H×D)	700×575×297			
Weight(kg)	60			
Topology	Transformerless			
Internal consumption	<1W(Night)			
Operating temperature	-25 ~ 65 °C, >45 °C derating			
Ingress protection	IP65			
Noise Emission(Typical)	≤50 dB	≤55 dB		
Cooling Concept	Smart cooling			
Max. operation altitude	2000m			
Designed Lifetime	>20 Years			
Grid Connection Standard	VDE4105, IEC61727/62116, VDE0126, AS4777.2, CEI 0 21, EN50549-1, G98, G99, C10-11, UNE217002, NBR16149/NBR16150			
Operation surrounding humidity	0~100%			
Safety EMC / Standard	IEC/EN 61000-6-1/2/3/4, IEC/EN 62109-1, IEC/EN 62109-2			

General Data

DC Connection	MC-4 mateable
AC Connection	IP65 rated plug
Display	LCD1602
Interface	RS485/RS232/Wifi/LAN

2022-12-22 Ver: 2.3

NINGBO DEYE INVERTER TECHNOLOGY CO., LTD.

Add: No.26-30, South Yongjiang Road, Beilun, 315806, Ningbo, China

Tel: +86 (0) 574 8622 8957

Fax: +86 (0) 574 8622 8852

E-mail: service@deye.com.cn

Web: www.deyeinverter.com



30240301001082